



RADIO'S LIVE

# Radio Craft

WESLEY GERNSBACK, Editor

HOW TO MAKE  
**A COMPLETE 5-METER  
PORTABLE STATION**  
See Page 196



**5-Meter Transceivers—French Radio Show—Beginner's Short-Wave Receiver  
Making a Metal-Tube All-Wave Service Oscillator—Self-Tuning Radio Set!**



# Your Chair, Mr. Serviceman

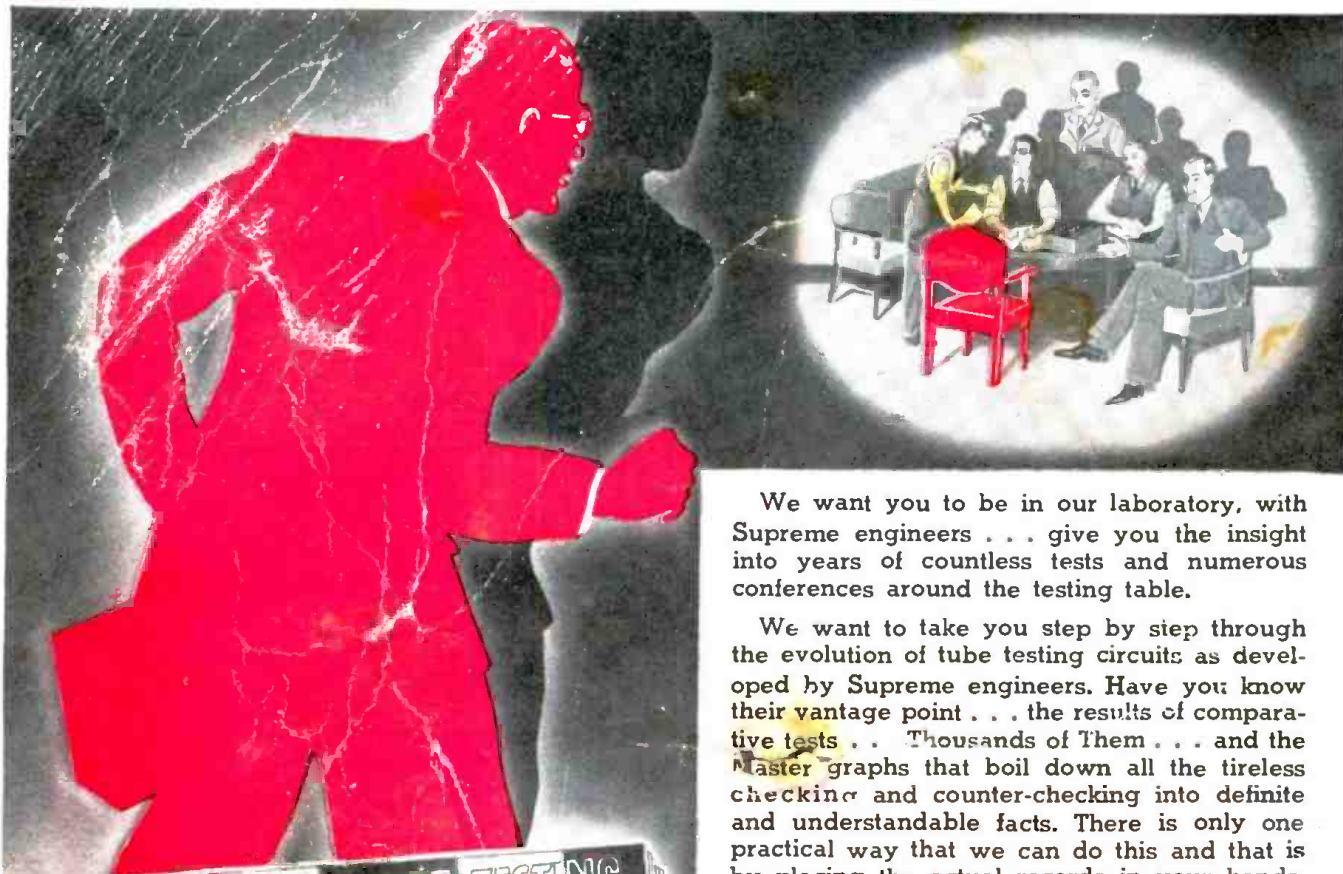

We want you to be in our laboratory, with Supreme engineers . . . give you the insight into years of countless tests and numerous conferences around the testing table.

We want to take you step by step through the evolution of tube testing circuits as developed by Supreme engineers. Have you know their vantage point . . . the results of comparative tests . . . Thousands of Them . . . and the Master graphs that boil down all the tireless checking and counter-checking into definite and understandable facts. There is only one practical way that we can do this and that is by placing the actual records in your hands.

This we have done through the medium of two Supreme brochures. One, the new catalog with full page illustrations and complete detailed descriptions of each instrument. The other, "The Evolution of Tube Testing," giving in diagrammatic detail every test; comparisons of circuits, and illustrated results . . . virtually a lecture and resume of all our experience since the beginning of radio.

It's your chair around the conference table with Supreme engineers, Mr. Radioman, giving you, in a brief period of time, the results of years of experiments and research.

Every radioman who aims to be up-to-date in his professional knowledge needs these booklets and the wealth of technical information they contain. Free upon request from Supreme Instruments Corporation, Greenwood, Mississippi, producers of the most outstanding instruments in radio service history—Supreme 1936 instruments.

## Supreme Instruments Corp.

Greenwood, Mississippi, U. S. A.

Export Dept., Associated Exporters Co., 145 W. 45th St.,  
New York City, N. Y. Cable Address: LOPREH, N. Y.







STUDENTS BUSY AT WORK IN LARGE COYNE SHOPS

# Learn RADIO

**SEND TODAY FOR DETAILS OF MY Pay-Tuition-after-Graduation Plan!**

Train for Radio in 90 days, right here in the big Coyne Shops — not by correspondence — but on real Radio, Sound and Television equipment. Mail the coupon below. If you are short of money I'll send you all details of my finance plan and consider your application. If accepted, you won't have to start paying tuition back until five months from the date you start school, and then you'll have over a year to complete your payments.

## Tremendous Developments Ahead in Radio and Television!

**H**ERE is YOUR opportunity to cash in. Every day brings news of new developments in every branch of Radio and Television, with more opportunities, more jobs, and a greater future for the trained man than ever before. I consider the fellow who is ambitious enough to want to get ahead by taking my Training, worthy of my help. **MAIL THE COUPON BELOW** and you can prove to me that you are willing to spend just 12 weeks in the Coyne Training Shops learning Radio. Then, I'll tell you about my finance plan which has enabled many to get complete Training and pay tuition back later.

## Learn By Doing In 90 Days

I don't care whether you are 16 or 45. It makes no difference to me if you don't know an oscillator from a spark coil. You don't need any previous experience or advanced education to master my Shop Training. Don't let lack of money hold you back from getting all details of my amazing plan.

### MANY EARN While LEARNING

If you need part-time work to help pay your living expenses and will tell us your problems we may be able to help you as we have thousands of others. Then, in 12 brief weeks, in the great Training shops of Coyne, you will learn on a wide variety of modern, up-to-date A. C. Super-heterodyne sets, oscillators, analyzers and test instruments. Prepare for Amateur Broadcast, or Telegraph Radio Operator's License and to know all code and Dept. of Commerce rules for government License Examination.

### TRAINING

#### By Actual Work

No dull books . . . you get individual training . . . real actual work with only the theory you will need. Building real radio sets,



### Auto Radio Instruction Prepare For Jobs Like These

Here are a few of hundreds of positions in the Radio field. My free employment bureau gives you life-time employment service.

- AIRCRAFT RADIO OPERATOR
- SHIP RADIO OPERATOR
- RADIO SERVICING
- PUBLIC ADDRESS SYSTEMS
- BROADCAST STATION OPERATOR
- TALKING PICTURE STUDIOS
- TELEVISION LABORATORY MAN

doing radio wiring and testing, trouble-shooting, repairing and servicing. That's a glimpse of how we help to make you a Radio expert, and fit you to qualify for jobs leading to the biggest pay.

### Jobs • Pay • Future

"I got my present job two days after graduation, at shorter hours, and wages increased 60% over my old job," reports Arne Wiklem of Minnesota. "I have my own shop, own a real car and make fine money in the radio business," writes E. Allen of Montana, "All this is possible because I came to Coyne." And I could go on quoting from hundreds of letters of successful Coyne Trained men. What they have done, you should be able to do.

### Electric Refrigeration Air Conditioning

Right now I'm including my new Electric Refrigeration and Air Conditioning course at no extra cost.

### GET THE FACTS

Coyne is your one great chance to get into Radio. This school is 36 years old—Coyne training is tested—proven beyond all doubt—endorsed by many large concerns. You can find out everything absolutely free. Simply mail the coupon and let me send you the big, free Coyne Book with photographs . . . facts . . . jobs . . . salaries . . . opportunities. Tells you how many earn expenses while training and how we assist our graduates in the field. This does not obligate you. So act at once.

**MAIL Coupon Today for FREE! BOOK!**



*H. C. Lewis*



### Home of Coyne Shops

This is our fireproof modern Building wherein is installed thousands of dollars' worth of Radio equipment of all kinds. Every comfort and convenience has been arranged to make you happy and contented during your Training.

**COYNE** H. C. LEWIS, President **Founded 1899**  
**RADIO & ELECTRICAL SCHOOL**  
 500 South Paulina Street Dept. 16-8H Chicago, Ill.

**H. C. LEWIS, President**  
**Coyne Radio & Electrical School**  
 500 S. Paulina St. Dept. 16-8H, Chicago

Dear Mr. Lewis: Without obligation send me your big free catalog and all details, also tell me all about your "Pay-Tuition-After-Graduation" Plan.

Name.....Age.....  
 Address.....  
 City.....State.....

Please Say That You Saw It in RADIO-CRAFT



## CONTENTS—JAN., 1936, ISSUE

Volume VII

Number 7

Editorial: The Short-Wave Industry.....Hugo Gernsback	388B
Radio Month in Review.....	390
New Equipment at the Paris Radio Show.....	392
International Radio Review.....	393
Short-Wave Pictorial.....	394
Radio Views of the News.....	395
How to Make a Complete 5-Meter Portable Station .....Howard G. McEntee	396
Making a Tuned All-Wave Antenna.....J. B. Carter	397
A 5-Meter Antenna Directive-Beam Array .....Samuel M. Wertheimer	397
Television and the Ultra-Short Waves.....W. E. Schrage	398
A 3-Tube "Single Signal" S.-W. Superheterodyne .....McMurdo Silver	399
A Complete 5-Meter Transceiver "Station" .....J. T. Bernsley	399
Reproducers for use in S.-W. Receivers.....D. H. Wright	400
Metal Tubes and the New S.-W. Set.....James Millen	400
A 5-Tube A.C.-D.C. "Turret" All-Wave Set .....H. G. Cisin	401
Operating Notes.....	402
Choosing the I.F. for All-Wave Supers.....A. Ghirardi	403
Aligning All-Wave Receivers.....O. J. Morelock	403
A Simple 2-Tube A.C. S.-W. Converter.....R. G. Herzog	404
An A.C.-D.C. 1-Tube All-Wave Portable.....H. A. Harris	404
For Beginners—a "4-in-2" A.C.-D.C. Short-Wave Set.....Donald Lewis	405
Useful Circuit Ideas.....	406
How to Make a Floating-Grid Relay.....E. L. Deeter	407
An Improved Line-Noise Filter for All-Wave Sets .....Arthur H. Lynch	407
The New "Self-Tuning" Radio Receiver.....	408
New French "Radio Furniture".....	408
The Listening Post for All-Wave DX-ers.....	409
A Novel A.C.-D.C. Phono-P.A. System.....A. C. Ansley	410
New "Spherical" Microphones are Non-Directional.....	410
Servicing Theatre Sound Systems, Part II.....A. V. Ditty	411
An Easily-Built Short-Wave Preselector.....Paul O'Connor	412
An "Acorn"-Type Ultra-S.-W. Super.....Hubert Shortt	412
RADIO-CRAFT'S Information Bureau.....	413
How to Make the RADIO-CRAFT Metal-Tube All- Wave Oscillator.....C. W. Palmer	414
A New A.C. Voltage and Power-Level Meter .....Milton Reiner	415
An "Acorn"-Tube V.-T. Voltmeter.....A. G. Heller	415
The Latest Radio Equipment.....	416
A 1936 9-Tube S.-W. Communication Receiver .....W. Willner	417
A 1-Tube Battery-Type 5- and 10-Meter Transceiver .....Maxwell M. Hauben	417
<b>RADIO SERVICE DATA SHEETS:</b>	
No. 153—RCA Victor Model T5-2 5-Tube, 2-Band A.C. Superhet. Receiver; RCA Victor Model C9-4 9-Tube 3-Band Super.....	418
No. 154—American Bosch Model 430T 5-Tube 3- Band Superhet.; Ward's Airline Series 7GM 7-Tube High-Fidelity Receiver.....	420
ORSMA Forum.....	422
Technicians' Data Service.....	423
Book Reviews.....	444

HUGO GERNSBACK, Editor-in-Chief

C. W. PALMER  
Associate Editor

H. G. McENTEE  
Associate Editor

R. D. WASHBURNE, Technical Editor

## NEW (ANNUAL) BROADCAST NUMBER

Watch for the next issue of *Radio-Craft* in which you will find descriptions of all the new developments of vital interest to everyone owning a radio set.

Service Men, too, will find described in this forthcoming annual BROADCAST NUMBER of *Radio-Craft* important information concerning the latest advances in servicing equipment and procedure. An interesting article on testing metal tubes is presented.

All-wave receivers appear to have obsolesced the single-range receiver. However, the phenomenally efficient performance of the all-wave set was not achieved until seemingly insurmountable obstacles were overcome. The discussion of some of these problems makes interesting reading.

RADIO-CRAFT is published monthly, on the first of the month preceding that of date; its subscription price is \$2.50 per year. (In Canada and foreign countries, \$3.00 a year to cover additional postage.) Entered at the post office at Mount Morris, Ill., as second-class matter under the act of March 3, 1879.

Text and illustrations of this magazine are copyright and must not be reproduced without permission of the copyright owners. We are also agents for WONDER STORIES and EVERYDAY SCIENCE AND MECHANICS. Subscription to these magazines may be taken in combination with RADIO-CRAFT at reduced Club rates. Write for information.

Copyright 1935. Continental Publications, Inc.

HUGO GERNSBACK, President I. S. MANHEIMER, Secretary

Published by Continental Publications, Inc. Publication office: 404 N. Wesley Ave., Mount Morris, Illinois. Editorial and Advertising Office: 99 Hudson Street, New York City. Chicago Advertising Office: L. F. McClure, 919 North Michigan Avenue, Chicago, Ill. Western Advertising Office: Loyd B. Chappell, 511 So. Alexandria St., Los Angeles, Calif.

European Agents:

London—Gorrings's American News Agency, 9A Green St., Leicester Square, London, W. C. 2.

Paris—Messageries Dawson, 4 Rue Faubourg, Poissonniere, Paris, France.

Australian Agent: McGill's Agency, 179 Elizabeth St., Melbourne.



# WHAT MAKES THE NEW *Triplett* MASTER UNIT TEST SET

# A Complete Servicing LABORATORY?

One compact portable case contains the four units necessary for expert radio service work.

Every unit is a Professionals' Instrument.

Every instrument has exclusive Triplett Features.

Model 1206 has Model 1231 All-Wave Signal Generator.

Model 1207 has Model 1232 All-Wave Signal Generator.

### All-Wave Signal Generators

Model 1231 D.C. or Model 1232 A.C., Dealer Net .....\$26.67

Note exclusive Triplett feature . . . Direct-Reading Scale . . . Six Bands . . . Vernier. Easy to read . . . Easy to operate . . . Precision built.

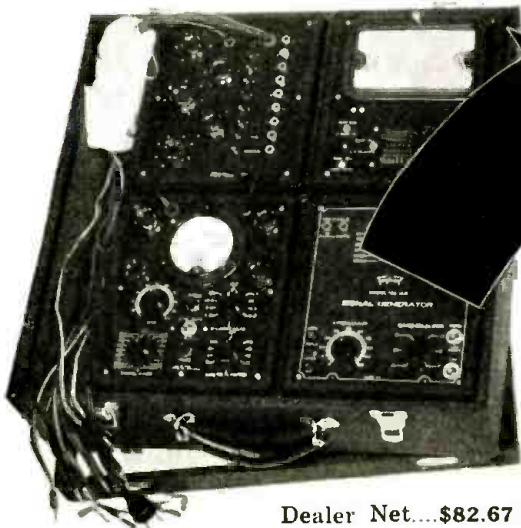
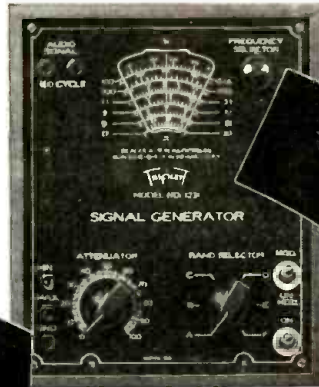

Dealer Net...\$82.67

The new 1936 Triplett Master Unit Test Set Model 1206 includes the new Direct Reading All-Wave Signal Generator either battery operated Model 1231 or A.C. operated Model 1232.

This new All-Wave Signal Generator by Triplett marks a great improvement in signal generator design. It is direct reading with vernier and has a single switch with pointer, for setting to any one of the six frequency bands covering all ranges from 100 to 30,000 kc.

All frequencies are fundamentals and fully stabilized. It has perfect attenuation, especially low loss switching, and all parts are of low capacity. Furthermore parts are non hydroscopic and thoroughly shielded throughout. Two jacks are provided for obtaining a 400 cycle audio note.

The four units contained in the Model 1206 Master Unit Test Set as well as the carrying case can also be purchased separately, and the complete servicing laboratory built up over a period of time. The four units are:

- Model 1200 Volt-Ohm-Milliammeter, Dealer Net Price.....\$21.67
- Model 1210-A Tube Tester, Dealer Net Price..... 20.00
- Model 1220-A Free Point Tester, Dealer Net Price..... 8.33
- Model 1231 D.C. (or 1232 A.C. All-Wave Signal Generator in Model 1207), Dealer Net Price ..... 26.67
- Model 1204 Leatherette Carrying Case, Dealer Net Price..... 6.00

Write for Complete Catalogue. See them at your jobber.

## TRIPLETT MANUFACTURES

A complete line of electrical measuring instruments for radio, electrical and general industrial purposes both standard and custom built. See them at your jobbers. If you have an electrical instrument problem write to TRIPLETT.



### Mail This Coupon!

Triplett Electrical Instrument Co.  
161 Harmon Drive  
Bluffton, Ohio

Please send me full information on Model 1206 Triplett Master Unit Test Set.....

Catalogue.....

Name.....

St. Address.....

City..... State.....

Please Say That You Saw It in RADIO-CRAFT

# Be Prepared to Meet All Radio Servicing Emergencies

## WITH GERNSBACK OFFICIAL RADIO SERVICE MANUALS



Just as we say—"Be prepared to meet all radio servicing emergencies with the Gernsback Official Radio Service Manuals." You never know when a service job requires that "extra" special attention. It might mean the difference between doing the job or losing it. You're safe if you have on hand the GERNSBACK MANUALS—either for regular service work or for servicing auto-radios. Get your copy today!

No other radio book is comparable to the new 1935 OFFICIAL RADIO SERVICE MANUAL. In contents, in style of printing, in grade of paper, in illustrations, there has never been published such a comprehensive volume.

This Manual contains over a thousand pages—yet it is only 1 1/4 inches thick because it is printed on a special Bible stock which is an exceptionally good stock, yet one of the thinnest and most durable papers. This 1935 Manual is the most authentic and elaborate service guide ever used in the radio industry.

### Contents of the 1935 Manual

Over 1,000 pages full of diagrams and essential information of manufactured receivers—only data of real use in servicing is included. This new Manual is really portable since it is extremely thin and light as well. ● Volume V continues where the preceding manual left off. ● Many circuits of old sets are included. ● Service Men know every set has certain weak points which are really the cause of trouble. Wherever the information could be obtained, these weaknesses with their cures are printed right with the circuits. This is an entirely new and valuable addition to the Manual. ● All the latest receivers are included—all-wave sets, short-wave sets, auto-radio sets, midset and cigar-box sets, etc., as well as P.A. Amplifiers and equipment,

and commercial servicing instruments. ● The cumulative index is even more complete than before; including cross-references to sets sold under different names and type numbers. ● Volume V includes resistance data; socket layouts; I.F. data; and voltage data. ● Tube data on latest tubes. ● Free question and answer service—as included in our last three manuals.

### OVER 1000 PAGES

Over 3,000 Illustrations  
Size 9" x 12"—only 1 1/4" thick  
Flexible, looseleaf leatherette cover

**SET SERVICING**  
Service information found in the Manuals covers all types of radio receivers. The material is extremely valuable to Dealers and Service Men. On many diagrams appear voltage readings of tubes, socket connections, transformer data, alignment details, and other service notes.

**PUBLIC ADDRESS**  
The pages on P.A. Installation will be helpful to Service Men and P.A. specialists. Such prominent features as class A and B amplifiers—single and dual channel systems—attenuators, and mixers—superpower stages—preamplifiers and other commercial devices for P.A. work are included.

**ALL WAVE RECEIVERS**  
Information relative to short-wave receivers have found their way into the Manuals. For these standard manufactured sets, wherever possible, complete aligning details for all wave bands are included in addition to the service material listed for other sets.

**AUTO-RADIO RECEIVERS**  
All available service information on new auto-radio sets has been included. From this data alone Service Men could derive sufficient knowledge to venture in a specialty field—that of servicing only auto-radios.

\$7.00  
List

### Which of These GERNSBACK RADIO SERVICE MANUALS Do You Need to Complete Your Files?

**1934 Official Radio Service Manual**  
Over 400 Pages. 9x12 Inches.  
Over 2,000 Illustrations  
Flexible, Looseleaf. Leatherette Cover  
List Price \$3.50

**1933 Official Radio Service Manual**  
Over 700 Pages. 9x12 Inches.  
Over 2,000 Illustrations.  
Flexible, Looseleaf. Leatherette Cover  
List Price \$5.00

**1932 Official Radio Service Manual**  
Over 1,000 Pages. 9x12 Inches.  
Over 2,000 Illustrations  
Flexible, Looseleaf. Leatherette Cover  
List Price \$5.00

**1931 Official Radio Service Manual**  
650 Pages (Including Supplements)  
9x12 Inches  
Over 1,500 Illustrations  
Flexible, Looseleaf. Leatherette Cover  
List Price \$4.50  
(Including Supplements)

**1933 Official Auto-Radio Service Manual (Volume I)**  
Over 200 Pages. 9x12 Inches.  
Over 500 Illustrations.  
Flexible, Looseleaf. Leatherette Cover  
List Price \$2.50

—for the real auto-radio servicing "dope," you can't find a better book!

### The 1935 Official Auto-Radio Service Manual

Every radio man connected in any way with the booming auto-radio business needs a copy of the new OFFICIAL AUTO-RADIO SERVICE MANUAL. It contains only auto-radio service "dope."

#### HERE ARE HIGHLIGHTS OF THE 1935 AUTO-RADIO SERVICE MANUAL

240 pages crowded with diagrams, service material and other essential data required for proper servicing of new auto-radio receivers. Included are diagrams of sets which appeared during 1934, and which were not included in the supplement to the first edition. Complete schematic diagrams, chassis layouts, voltage regulations and servicing instructions are included for practically all sets. "Under-side" tube symbols are also included to facilitate the job of servicing the sets. Instructions are included with many sets telling how to substitute stubborn cases of ignition interference. This includes the newest "suppressorless" sets and what to do when interference is encountered with this type of set. Details on how to make metal filings in "turret-top" sets are included. The different methods used by car makers and set manufacturers are listed with the individual circuits and service information. The index contains the listing of sets which were published in the first edition, as well as the sets which appear in the new volume. This information helps the Service Man to locate the circuit and details for any receiver that has been made. The book is bound in a handy, flexible leatherette cover. To insure the pages are sturdy, to withstand constant use, the book is printed on a special "Bible" stock. This is a very durable, but thin paper. The book printed on this paper can be easily rolled to fit into your pocket or slipped in the service kit.



240 Pages  
Over 500 Illustrations  
Size 9 x 12"

Flexible, Looseleaf Leatherette Cover

\$2.50  
LIST

### MAIL COUPON TODAY FOR ANY MANUAL!

GERNSBACK PUBLICATIONS, Inc. RC-136  
99 Hudson Street, New York, N. Y.

Enclosed you will find my remittance of \$ ..... for which please send me promptly, POSTPAID, the OFFICIAL RADIO SERVICE MANUAL indicated.

- |  |  |
|--|--|
| <input type="checkbox"/> 1935 Edition @ \$7.00                         | <input type="checkbox"/> 1935 Edition @ \$2.50 |
| <input type="checkbox"/> 1934 Edition @ \$3.50                         | <input type="checkbox"/> 1933 Edition @ \$2.50 |
| <input type="checkbox"/> 1933 Edition @ \$5.00                         | <input type="checkbox"/> 1933 Edition @ \$2.50 |
| <input type="checkbox"/> 1932 Edition @ \$5.00                         |  |
| <input type="checkbox"/> 1931 Edition @ \$4.50 (Including Supplements) |  |

Name .....  
Address .....  
City ..... State .....

(Send remittance by check, money order, or register letter if it contains cash, currency or unused U. S. Postage Stamps.)

**GERNSBACK PUBLICATIONS, Inc.**  
99 Hudson Street New York, N. Y.

**OVERSEAS READERS!**  
These books can be obtained from the following houses:

**GREAT BRITAIN**  
Gorrings's, 9a, Green Street, Leicester Square, London, England

**FRANCE**  
Editions Radio, 42 Rue Jacob, Paris

**AUSTRALIA**  
McGill's 183-195, 218 Elizabeth St., Melbourne, C. I

Please Say That You Saw It in RADIO-CRAFT



# WHAT'S NEW IN RADIO

## OLD-TIME SERVICEMEN LOSING OUT WITH THEIR HIT-AND-MISS METHODS

**RAPID DEVELOPMENT IN RADIO**—new and improved circuits—special purpose tubes—Radio's expansion into many allied fields—have created an increasing demand for Radio servicemen. BUT—only the trained servicemen—the men who have secured a firm grounding in the fundamentals of Radio, in modern service technique, and who have kept up with all the modern developments of Radio are in a position to take advantage of this.

**TODAY'S RADIO SERVICEMAN IS** a different person from the serviceman of five years ago. Today, the successful serviceman must really be a trained service engineer—capable, quick, ingenious, to solve the many problems he meets with when servicing the many types of Radios and other apparatus developed along Radio principles—which he is called on to repair, sell and service. The old-timer who simply changes tubes, pulls wires, holds his breath and hopes, can't get along today. On every side he sees efficient, trained men step into his shoes—go ahead faster—and make more money.

**ALL-WAVE AND HIGH FIDELITY RADIOS**, with their exact adjustments have brought forth many new service problems. This kind of service work requires a man with special knowledge and training. Not the old-time, hit-and-miss fellow. He may try—but he can't succeed. It's the well trained serviceman who cashes in. That's why we see many ambitious men everywhere getting into Radio service work—with sound training such as any man can get from the National Radio Institute. And that's why many servicemen with years of practical experience are also training themselves in the modern ways of servicing.

**MODERN SERVICING METHODS** are helping servicemen increase their earnings by greatly reducing the amount of time required to do a job. This enables them to handle a greater volume of work per day, and have more time to build up their businesses.

**AUTO RADIOS BRING SPECIAL SERVICE PROBLEMS.** The increasing volume of sales of Auto Radios is bringing with it an increased demand for trained servicemen who are capable of servicing Auto Radios quickly and thoroughly. Many new problems—such as ignition noises, insulation problems, servicing complicated and compact receivers, the ability to tell whether the car chassis or the receiver is to blame, vibrator defects—are being handled by modern, well-trained servicemen who are finding Auto Radio a means of increasing their incomes. Modern Radio schools—such as the National Radio Institute—are including thorough training in Auto Radio in their courses.

**NEW BOOK TELLS ABOUT RADIO'S DEVELOPMENTS.** Mr. J. E. Smith, President of the National Radio Institute, Washington, D. C., the oldest and largest Institute for training men for Radio through home study, has prepared a book telling all about the need for thorough training in Radio, for either "old" servicemen who want to prepare themselves for modern Radio servicing—or for the beginner who wishes to enter Radio either as a spare time or full time expert. Read the National Radio Institute's advertisement on the right—then mail the coupon for a FREE copy of Mr. Smith's book.

# I will help you START A SPARE TIME OR FULL TIME RADIO SERVICE BUSINESS Without Capital



J. E. Smith, President National Radio Institute

HERE ARE A FEW EXAMPLES OF THE KIND OF MONEY I TRAIN MY MEN TO MAKE

### \$3,500 Year in Own Business

"After completing the N. R. I. Course I became Radio Editor of the Buffalo Courier. Later I started a Radio service business of my own, and have averaged over \$3500 a year."—T. J. TELAAK, 356 Hewitt Avenue, Buffalo, N. Y.



### \$80.00 Monthly in Spare Time



"I work on Radio part time, still holding my regular job. Since enrolling five years ago, I have averaged around \$80 every month, giving me a total of about \$5000."—JOHN B. MORISSETTE, 773 Silver Street, Manchester, N. H.

### \$2,000 in Year for Former Plumber

"When I took up the N. R. I. Course, my work as a plumber was getting less and less. I am doing fine with my service work now. The profits for the past twelve months have been about \$2000. For anyone wishing to enter Radio, I recommend N. R. I."—L. A. TODD, 628 Cornell Street, Ottawa, Ill.



### GET MY FREE LESSON on Radio Servicing Tips

I'll prove that my training is practical, money-making information, that it is easy to understand—that it is just what you need to master Radio. My sample lesson text, "Radio Receiving Troubles—the Cause and Remedy" covers a long list of Radio receiver troubles in A.C., D.C., battery, universal, auto, T. R. F., super-heterodyne, all wave, and other types of sets. And a cross reference system gives you the probable cause and a quick way to locate and remedy these set troubles. A special section is devoted to receiver check-up, alignment, balancing, neutralizing and testing. Get this lesson Free. No obligation. Just mail coupon.

## Free Book Tells How. Mail Coupon!

The world-wide use of Radio sets for home entertainment has made many opportunities for you to have a spare time or full time Radio business of your own. The day you enroll I start sending you Extra Money Job Sheets which quickly show you how to do Radio repair jobs common in most every neighborhood. Many N. R. I. men make \$5, \$10, \$15 a week extra in spare time while learning. I show you how to install and service all types of receiving sets. I give you Radio equipment and instructions for conducting experiments, for building circuits and testing equipment and for making tests that will give you broad practical Radio experience. Clip the coupon below and get my free 64-page book, "Rich Rewards in Radio"—it gives you a full story of the success of N.R.I. students and graduates, and tells how to start a spare time or full time Radio business on money made in spare time while learning.

## Many N. R. I. Men Make \$5, \$10, \$15 a Week Extra in Spare Time While Learning

Many of the twenty million sets now in use are less than 50% efficient. I will show you how to cash in on this condition. I will show you the plans and ideas that have enabled many others to make \$5, \$10, \$15 a week in spare time while learning. Anthony Yeminas, 269 Vine Street, Plymouth, Pa., writes: "While taking your Course, I made over \$300 in my spare time."

school or college education. Hundreds with only a common school education have won bigger pay through N.R.I. training. Graduate J. A. Vaughn jumped from \$35 to \$100 a week. Fred D. Silvernail increased his income nearly 100%. The National Radio Institute is the Pioneer and World's Largest organization devoted exclusively to training men by Home Study for good jobs in the Radio industry.

### Get Ready Now for a Radio Business of Your Own and for Jobs Like These

Broadcasting stations use engineers, meterers, station managers, and pay up to \$5,000 a year. Radio manufacturers use testers, inspectors, foremen, engineers, servicemen and buyers, and pay up to \$4,000 a year. Radio dealers and jobbers employ hundreds of servicemen, salesmen, managers, and pay up to \$3,000 a week. Radio operators on ships enjoy life, see the world, with board and lodging free, and get good pay besides. My book tells you of the opportunities in these fields, also in Aviation Radio, Television, Police Radio, Short Wave Radio, Automobile Radio and other new branches of this fast growing industry. Get it.

### You Must Be Satisfied

I will give you an agreement to refund every penny of your money if you are not satisfied with my Lesson and Instruction Service when you graduate. And I'll not only give you thorough training in radio principles, practical experience in building and servicing sets, but also Advanced Specialized Training in the type of Radio work you choose.

### Get My Free Book of Facts

Mail the coupon for "Rich Rewards in Radio." It's free to any ambitious fellow over 15 years old. It tells you about Radio's spare time and full time opportunities; about my training; what others who have taken it are doing and earning. Mail without in an envelope, or paste it on a 1c post card.

### I Train You at Home in Your Spare Time

Hold your job until you're ready for another. Give me only part of your spare time. You do not need a high

J. E. Smith, Pres. Dept. 6AX National Radio Institute Washington, D. C.

This Coupon is Good for One FREE Copy of My Book



J. E. SMITH, President, National Radio Institute, Dept. 6AX Washington, D. C.

Dear Mr. Smith: Without obligation, send me the Sample Lesson and your free book about spare time and full time Radio opportunities, and how I can train for them at home in spare time. (Please write plainly.)

Name ..... Age.....  
Address .....  
City ..... State..... 14x-1

Please Say That You Saw It in RADIO-CRAFT



# THE SHORT WAVE INDUSTRY

An Editorial by HUGO GERNSBACK

**R**ADIO has always had the trick of splitting itself into various units, ever since the days of Marconi's early experiments. As a matter of fact, practically all the branches and sub-branches of radio keep on expanding at such a fast pace that it is almost impossible even for engineers to keep themselves informed of the rapidly changing picture.

*Short-wave radio* is no exception to the rule. Indeed, the short-wave branch threatens to overwhelm the entire industry and it will not be many years before short waves will become the major part of the radio industry itself.

The curious part of short-wave operation is that it is reverting to type. The original experiments by Heinrich Hertz in the '80s all were conducted on short waves: all classical experiments probably were conducted below 5 meters! Later on, when Marconi took hold of radio and began transmitting across the ocean, he did so at several thousand meters wavelength. Still later, ships went to 600 meters. Then, subsequently, when the broadcasting furore started, it dropped from 600 to 200 meters. The entire trend of radio since that time has been to go into the lower wavelengths, which means going up into the higher frequencies. When we talk about short waves, that is, for short-wave communication, the band between 200 and 5 meters is used most. But already, the wavelengths below 5 meters are becoming of great importance and will grow in importance as the years go on.

Meanwhile, most of our great broadcasters who emit speech and musical entertainment not only use the normal broadcast wavelength but short waves as well. There are now on the globe over 4,000 short-wave broadcasters of this type, and they are rapidly increasing in numbers and importance.

The radio-set industry quickly realized the trend of the times and for the past two years they have added short waves to the regular broadcast reception range. It may be said today, that a radio set is obsolete unless you can receive on the short-wave bands as well as the normal broadcast range.

The trend will continue in this fashion. An entirely new set-building industry has recently sprung up which is taking care of those individuals who wish to receive short waves only, and who are not interested in broadcasting. Special short-wave sets are made for this purpose. Greater refinements are being added from day to day.

It is unfortunate that the radio-set industry has been very neglectful of the general public in connection with their so-called *all-wave* sets. The public not having any conception of the difference between short waves and broadcast waves, has become very impatient and in many cases condemned an otherwise good set simply because the set-building industry has not seen fit to warn the non-technical user that *you cannot receive short waves in the same manner as you can receive broadcast waves*. At the present time, you cannot sell a set and tell the customer that you

can get London, Berlin, Tokio, and other stations the same as your locals day in and day out, any time of the day. Nor is the tuning for short waves easy. A glib salesman in the store knowing little or nothing about short waves thus often sells a set by such misrepresentation.

The average man does not know that short waves fade, that they come in best only at certain times of the day or night, and that there are other vagaries to which you must become accustomed. Very few all-wave set manufacturers have gone to the trouble to issue booklets and directions so that the public will understand these points. This is particularly unfortunate because the newspapers are playing up short waves as they never have before. The Radio Manufacturers Association recently got out a large publicity release calling the radio trade's attention to this tremendous publicity which the newspapers are carrying on gratis, the industry being the greatest beneficiary.

Short waves today are NEWS, and will continue to be so. Short waves are in the public's eye, but it is up to the industry to do away with misrepresentation if it is to prosper.

Nor are the wonders of short waves diminishing. A tremendous amount of newspaper and motion picture news publicity was recently released when Henry Ford, from a moving automobile in Schenectady, held a two-way conversation with one of his branch stores in South America! It will not be many years now before all of our automobiles will be radio equipped in such a manner that we can actually talk to our homes and friends while we are hundreds of miles away. And it makes little difference whether we are in our automobile or in our motorboat, the facilities will be there just the same. This thing is much nearer in fulfillment than most of us realize.

Of course, talking thousands of miles from home is nothing new. There are today a dozen or more luxurious, radio-phone-equipped steamships from which you can speak to your home—the only fly in the ointment being the cost. At the present time, the transatlantic traveler who wishes to radio-telephone must pay \$9.00 when the ship is out approximately 500 miles. Above this distance, the price jumps to \$18.00 for a three-minute ship-to-shore conversation, and this is, of course, only for the vicinity of New York. If the call is to go further west or south or north, extra toll charges are added. The impression of transatlantic travelers is that the initial charge is entirely too high and unwarranted and that the ship-to-shore traffic would increase a hundredfold if the charge were reduced.

The trouble at the present time is that when you talk from ship to shore for three minutes you will be tying up several million dollars worth of equipment, and if looked at in this light, the charge of \$9.00 or even \$18.00 is not so extravagant.

It is certain that charges such as these will be reduced in time, as, due to more sensitive equipment, and other factors such as multiplicity of channels, etc., the cost of making the call will be greatly reduced.



# Be a RADIO EXPERT

## THE ONE MAN IN 1000 WHO CAN SERVICE MODERN RADIO RECEIVERS

**RADIO SERVICE WORK NOW OFFERS GREATEST OPPORTUNITIES SINCE RADIO BEGAN.....**

Radical changes have taken place in radio receiver design during the past year. Circuits and construction are very different from the receivers with which the radio service industry has had its greatest experience. Even more sensational developments with further complications are coming next season. Who will service these receivers? Certainly not the "old timer" who knows nothing about modern receivers! He can't do it. That is why, right now, there is an urgent demand for reliable service men with up-to-the-minute knowledge of modern radio receivers. Such men can step right out and earn up to \$3 an hour doing nothing but pleasant service work in the better homes around town.



**THIS CIRCUIT ANALYZER AND POINT-TO-POINT RESISTANCE TESTER INCLUDED FREE OF EXTRA CHARGE.**

*Also*  
**FOUR LARGE KITS OF HOME PRACTICE EQUIPMENT.....**

### No Past Experience Needed

Past experience actually counts for little at this time, because the swift changes in receiver construction have made knowledge of old equipment practically useless. Even though you may not know one tube from another today . . . still, you can take R.T.A. training and make more money servicing modern radios than most of the "old timers" are making. R.T.A. graduates are doing it every day. Many of them are making more money as R.T.A. Certified Radio Technicians than they ever made in their lives before!

### Be An R. T. A. Man and You'll Be the One Man in 1000

R.T.A. training will equip you to give fast, complete service to any radio receiver built. The jobs that puzzle and sometimes baffle the usual service man will be simple as "A.B.C." to you . . . when you become an R.T.A. Certified Radio Technician. It is very possible that you will be the only service man in your locality able to quickly diagnose and quickly repair the new types of radio receivers. Be the one man in 1000! You can.

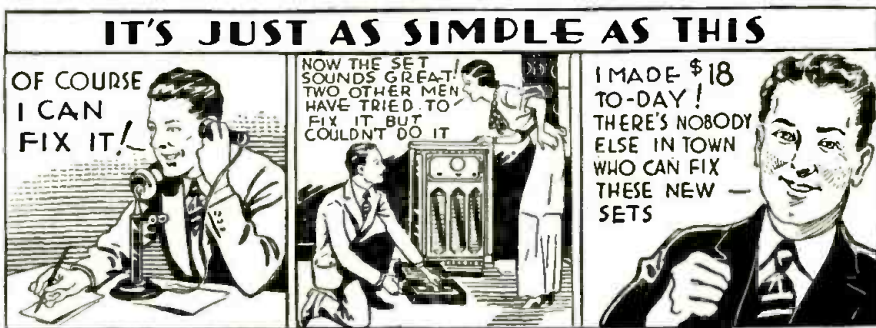

### R.T.A. Membership Keeps You Ahead of Competition

With your course of training, and without extra cost, you get a valuable lifetime membership in R.T.A. This gives you a big advantage over ordinary service men . . . because we constantly furnish *advanced* information to our members . . . information that puts money in your pocket while the other fellow is stumbling around in the dark.

### To Start You Making Money Right Away

Quickly following your enrollment for training with R.T.A. you get, *without extra cost*, the R.T.A. Set Analyzer and Resistance Tester . . . the handiest piece of portable service equipment ever devised. Instantly helps you locate the trouble in any type of receiver, old or new, and shows you precisely what to do about it.

#### SEND COUPON

A. G. Mohaupt, Engineer  
Radio Training Ass'n. of America  
Dept. RC-61, 4513 Ravenswood Ave., Chicago, Ill.

Dear Mr. Mohaupt: Please send me your free book of facts about radio opportunities and how I can make big money quickly. Also tell me how I can obtain your Set Analyzer and four big experimental outfits—FREE OF EXTRA CHARGE.

Name.....  
Address.....  
City..... State.....

## RADIO TRAINING

## ASSOCIATION of AMERICA

4513 Ravenswood Avenue

CHICAGO, ILLINOIS

Please Say That You Saw It in RADIO-CRAFT



# THE RADIO MONTH

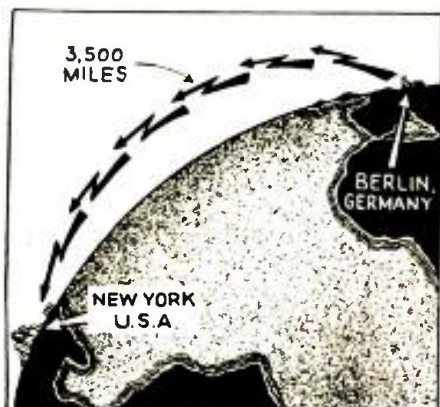

The remarkable distance covered by the Berlin television sound and view transmitter.

## TELEVISION 3,500 MILES ON 6 METERS!

**U**LTRA-SHORT waves, which have been considered to be quasi-optical in range, blossomed forth as full-fledged DX channels, last month, with a well-authenticated report that the 6-meter television transmitter operating near Berlin had been received in New York!

It was thought that the wavelength adopted for this transmitter, some 6 meters, would give a maximum service area of only 35 miles. but imagine the surprise of the officials of the station when they received a letter from a gratified New Yorker, who reported that he had not only heard the Berlin sound program but also had "looked in" on the television views!

The knowledge that ultra-shorts can cover long distances has come upon us gradually. In the May 1935 issue, page 646, we announced that a distance of 100 miles had been covered; in the September 1935 issue, page 135, this distance was increased to 600 miles; and now we have a goal of 3,500 miles to shoot at.

## SHORT-WAVE PROGRAM DEMAND

**P**UBLIC interest in short-wave radio made itself plain in rather an odd way, last month, when over 100 additional newspapers subscribed for the weekly short-wave foreign program tabulation issued by the Radio Manufacturers Association. This makes a total of over 700 newspapers receiving this unique service from the RMA.

This service is furnished to newspapers without charge as a new news feature for their readers, since the widespread use of short-wave and all-wave sets developed.

## RCA CRACKS DOWN ON SUPERHET. KITS

**F**OR years, RCA has stood by and allowed manufacturers of parts and set kits to make up kits for superheterodyne receivers, and sell these kits for home and custom-set builders—presumably on the basis that home experimenters would eventually buy a manufactured set of the superhet. type at which time they (RCA) would reap their profit—and who knows, some home experimenter toying with one of these kit sets might run across something really worthwhile, thus assisting the development of superhet.-type sets.

But during the past month or so, the "powers that be" in that firm have had a change of heart and all manufacturers of superhet. kits have been warned to obtain a license from the patent holders. The Tobe Deutschmann Corp. was first to comply.

## A CORRECTION ON PLANE CRASH

**S**EVERAL months ago, in the August 1935 issue, page 71, we announced a tragic plane crash as being due to defective radio equipment.

During the past month, we have received a letter from an official of the Transcontinental and Western Air, Inc., informing us that our report had proved to be inaccurate—the cause of the accident being erroneous weather reports radioed from Kirksville, Mo.

## SHORT WAVES IN THE NORTH WOODS

**U**LTRA-SHORT waves have found a new use in the Maine woods, where portable transceivers will be used in cases of persons becoming lost or where accidents happen in the remote places where woodsmen travel. News of this new application was received last month when this radio set was shown at "Brockton Fair" (Mass.).

An unusual use for ultra-short waves is communication from camps in the Maine woods.



## DUN AND BRADSTREET REPORT

**I**N THEIR periodic radio business report, last month, Dun and Bradstreet has some very encouraging facts to present to their subscribers. We quote:

"Sales of receiving sets for 1935 give indication of surpassing the all-time peak which has held since 1929. For the nine months, sales averaged 40 to 80 per cent ahead of the corresponding totals, while output was increased from 25 to 40 per cent, with the large-size models predominating.

"The stronger financial position of the buying public is indicated by the attitude of finance companies that are now soliciting radio paper, after a decided lack of interest in it for over 3 years."

## ALFRED H. GREBE DIES

**L**AST month, Alfred H. Grebe, a pioneer in radio when broadcasting was in its infancy, died, following an operation.

Mr. Grebe started making radio receivers in 1914 and within a few years had equipped his plant in Richmond Hill, L.I., to make both sets and parts. This factory each year turned out thousands of sets bearing the name "Grebe."

To stimulate public interest in radio, Mr. Grebe established several radio broadcast stations, including WAHG, which was sold, in 1926, to the Atlantic Broadcasting Corp. and changed to WABC.

Mr. Grebe will be missed from the ranks of radio pioneers!

A. H. Grebe, well known manufacturer, who died.





# IN REVIEW

Radio is now such a vast and diversified art it becomes necessary to make a general survey of important monthly developments. RADIO-CRAFT analyzes these developments and presents a review of those items which interest all.

## ZWORYKIN SHOWS NEW ELECTRON TUBE

**A** RADIO tube of radical design, so sensitive that it can replace 6 or more ordinary tubes was described last month, by Dr. V. K. Zworykin, before the members of the Institute of Radio Engineers. Incidentally this is the first tube that RCA has produced combining a glass envelope with an octal tube base.

Briefly, the tube operates as follows: inside the long envelope is a double row of electrodes extending the full length. The electrodes in one row are coated with caesium and act as "targets" for the electron stream. The electrodes in the other row supply electrostatic fields to guide the electrons in the desired path. Around the outside of the tube are permanent magnets which act to guide the electrons.

From a modulated light source (neon tube or Kerr cell) at one end of the tube, electrons are driven against the first target—as they hit the target, the impact sets free "secondary electrons," which tend to fly off in all directions but are restrained into the desired path by the electrostatic and magnetic fields. By properly spacing the electrodes, the augmented stream hops from one target to another, and reaches a sizable current flow when it reaches the positive plate at the other end of the tube. Gains of several million are possible with 10 reflections, *without increase in thermal tube noises!*

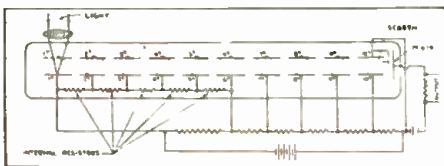

A schematic of the new tube, above, and Dr. Zworykin with one of the tubes, below.



## A.T. & T. SHELVES TELEVISION EXPERIMENTS!

**T**HE development of national television in the U.S. received a definite set-back, last month, when the A.T. & T. Co. acted upon resentment over a decision of the Federal Communications Commission which ruled that the A.T. & T. Co. could install coaxial cables for experimental purposes only if they made these cables available to all television experimenters—competitors or otherwise.

A.T. & T. claims that such a decision if accepted would void the patents controlling the coaxial cables and so, they have definitely postponed the installation of the first cable between New York and Philadelphia (see *Radio-Craft*, August 1935, page 70) until the Commission relaxes its regulations.

An official of the A.T. & T. Co., said that "they did not intend to give away the fruits of their labors to rivals."

Commissioner Walker of the F.C.C. said—"The Commission had in mind particularly television and such regulation as might prevent any one company gaining a complete monopoly."

## RADIO AT ADDIS ABABA

**U**NTIL last month, the entire radio connection between Ethiopia and the outside world depended upon one radio station—using the call letters E T A—upon which all diplomatic representatives and newspaper correspondents were dependent.

Last month, however, four expert radio men left from Washington for Addis Ababa to set up an emergency transmitter at the American Legation.

Short-wave fans will be interested also in the fact that E T A is now equipped as a radiotelephone station and has been picked up directly at Riverhead, L.I., for re-broadcasting. Here is a fine DX station to shoot for—signals on either 7.62 or 18.27 mcs.

The station measurement and control room of station E T A, in Addis Ababa.

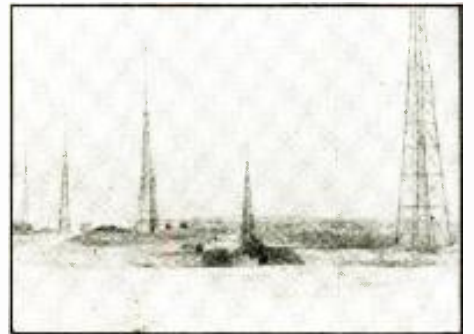
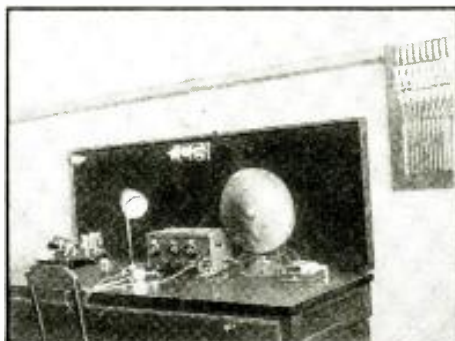

The Italian radio station in Morganisnu Somaliland, from which Italian reports are sent.

## TWO-RADIO HOMES IN THE U.S.

**T**HE two-car family so much discussed in the Hoover Administration has now been changed to the two or more radio-owning family.

According to figures which became available last month, there are 2,295,770 homes in the United States owning two or more radio receivers. This figure indicates that over 10 per cent of the radio homes in America own two or more receivers!

## AMATEUR HOURS CAUSE TROUBLE

**T**HE search for hidden talent is leaving woe in its wake—amateur hour entrants are adding to New York's army of unemployed, according to a report received last month.

It appears that radio's popular amateur hours which draw thousands of ambitious but penniless youngsters from all over the country are increasing New York City's relief problem.

Emergency Relief Bureau officials, declaring that 300 such embryo stars descend on the city every week, protested to Major Edward Bowes, originator of the amateur hour. The Major insisted that he has always stipulated that all his aspirants must be New Yorkers. But of course, Major Bowes' amateur hour is only one of the many now cluttering up the ether weekly!

## THE GOLDFISH IN THE STUDIO

**T**HERE is quite a good deal known about goldfish, but it remained until last month for news to come to light of their important position in the broadcast stations of the British Broadcasting Corp.

Only a few well informed people know that the officials at the huge broadcast station at Droitwich entrust 144 goldfishes (*Continued on page 424*)





The flower of the French radio industry represented by radio engineers, manufacturers and radio writers, on September 16 honored Hugo Gernsback by tendering him a special radio dinner during the Paris Radio Show.

# NEW EQUIPMENT AT THE PARIS RADIO SHOW

At the huge radio show which was held recently in Paris, many new devices were displayed. A few of these are described and illustrated here, for wide-awake radiomen.

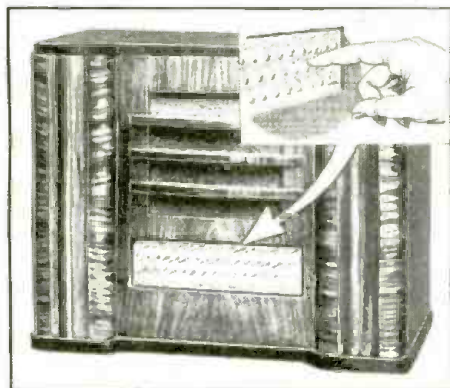

Figs. A and B, above. The "push-button" set which automatically tunes in stations.

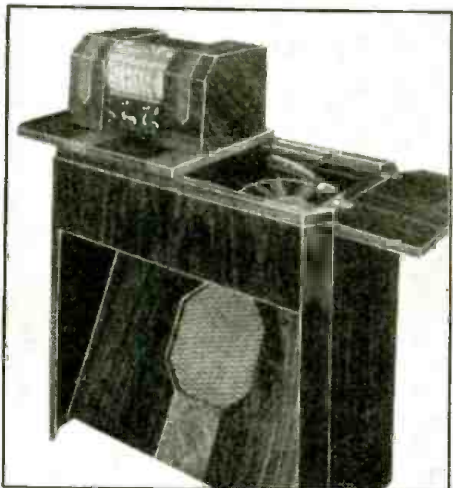
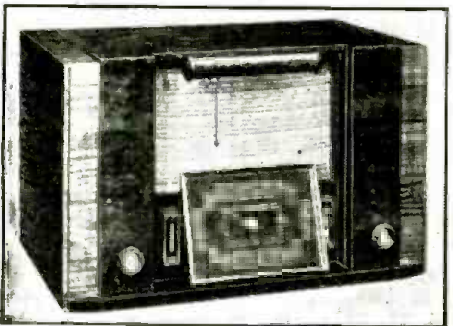

Fig. C, above. A sliding top radio-phonograph. Fig. D, below. Reading light illuminates dial.



**T**HE 1935 Radio Show which took place recently in Paris, France, brought to light a number of interesting and new receivers and devices—the results of a year of experimenting in the laboratories and factories in that country.

The show, which was the largest and most colorful of its kind in recent years attracted manufacturers and radio celebrities from all over the world.

An interesting sidelight to the show was an informal gathering at the *Café de la Paix*—arranged by editor Aisberg of *Toute la Radio*—of manufacturers, technicians and editors of technical publications given in honor of Hugo Gernsback, Editor and Publisher of *Radio-Craft* and other magazines. Mr. Gernsback gave an interesting two-hour talk in French on his early efforts in the radio field—how he predicted the future of "listening-in" which has developed into the great broadcast industry of today.

**Push-button set.** One of the most unusual sets on display was an advanced type of "push-button set" which permitted anyone of 45 different stations to be automatically tuned in by simply touching the correct button! (See "Making the Lazyman '4' Receiver," for data on an interesting "automatically-tuned" set of American design.—*Editor*) Two photos of the set, Figs. A and B, show the external appearance and a detail of the automatic blocking mechanism which stops the motor drive on the condenser shaft at the correct point. The protruding rods shown in Fig. B are set in the correct position when aligning the set, and do not have to be touched unless the station changes its transmission frequency. The receiver around which this automatic tuning arrangement is built, is a 6-tube superhet, having such features as "octode" frequency changer, interstation noise suppression, A.V.C., and diode detection.

**Artistic Radio-Phono. Design.** Another interesting item displayed for the first time was the radio-phonograph unit shown in Fig. C. A sloping baffle is used for the speaker, and the radio tuner is arranged on a *sliding shelf* on the cabinet top which, when moved to the left, exposes the phonograph turntable and pickup. The dial on this set is an over-size drum on which the station names are printed in large legible columns (it *Continued on page 421*)

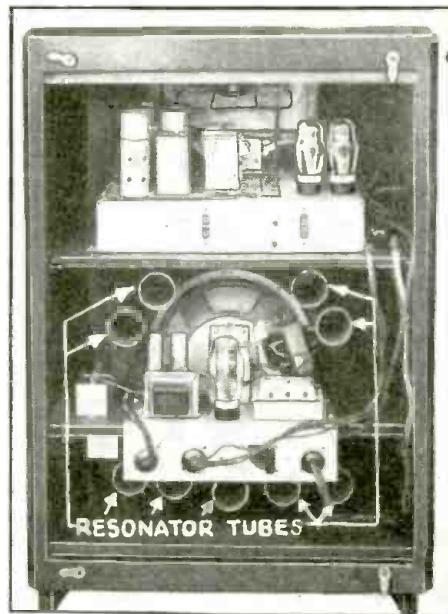

Fig. E. Tuned tubes absorb distorting tones.

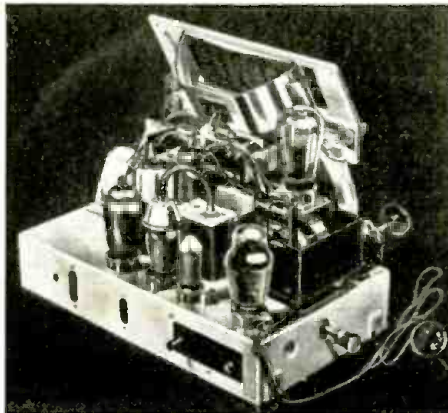

Fig. F. A new form of shadow-tuning dial.

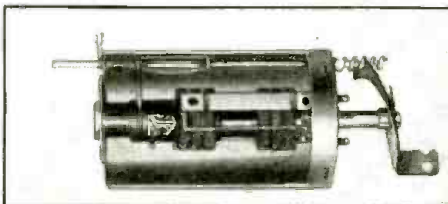
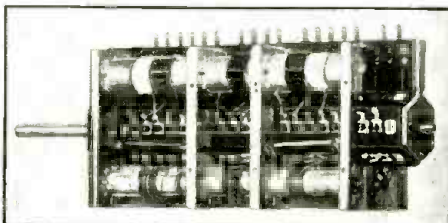

Fig. G, above. A variable selectivity I. F. T. Fig. H, below. A shielded all-wave tuner.





RADIO-CRAFT receives hundreds of magazines from all parts of the world. Since the cost of subscribing to each of these would be prohibitive for most radio men, we have arranged with technical translators to prepare reviews for our readers.

# INTERNATIONAL RADIO REVIEW

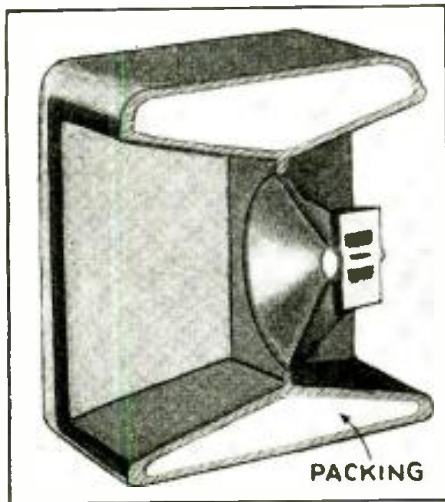

Fig. A  
The speaker and baffle—cut in half for exhibition purposes—note the baffle shape.

## A GERMAN SPEAKER ASSEMBLY

THE SUBJECT of high-fidelity reception is becoming more and more important to the set design engineer, as indicated by the novel ways in which wide-frequency response are obtained by different set manufacturers.

Designers in Europe are also becoming high-fidelity conscious, if articles appearing in recent issues of the radio magazines received from abroad can be used as a measure. In a recent issue of *Europa Stunde*, a magazine published in Berlin, a new form of speaker was shown. The illustration here, Fig. A, shows a demonstration model, cut in half so that the construction can be seen more readily.

A dynamic unit is mounted in the center of a double frustum which acts as a combined baffle and sound projector. The baffle is made of a sound absorbent material and is padded with asbestos to remove any trace of cabinet resonance.

Fig. B  
An English variable-selectivity I.F. transformer using iron-core coils—the secondary rotates.

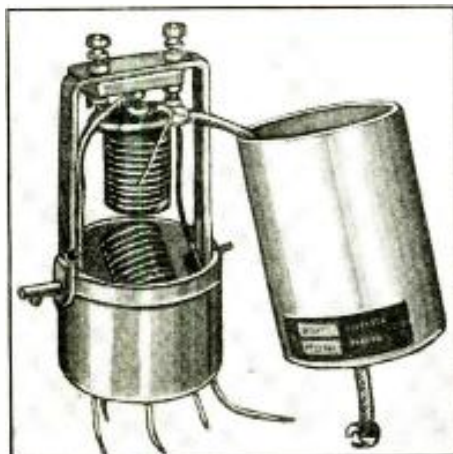

## VARIABLE SELECTIVITY I.F.T.

AN ENGLISH version of the variable selectivity I.F. transformer used in the construction of high-fidelity superheterodyne receivers was described in the latest issue of *Wireless World*. It is equipped with iron-core coils of the "pie wound" type recently advocated to supply the greatest possible "Q." Both primary and secondary are divided into 10 separate sections.

The primary winding has a tap  $\frac{1}{2}$ ths from the low-potential end for the plate connection—a method used in Europe for obtaining a step-up effect in band tuners.

Variation in the selectivity is effected by rotation of the secondary coil, as shown in Fig. B. The rotating rod is arranged so that several transformers can be ganged together.

## A NOVELTY IN DIALS

AN UNUSUAL type of dial is used in one of the new German receivers, shown in Fig. C. In addition to the usual visual scale, which indicates the location of the station according to the usual practice in Europe, an additional indicator is included which projects the name and frequency of the particular station in tune on a translucent screen.

This greatly facilitates the location of a station. It is a very attractive adjunct to the usual dial.

## VACUUM PROTECTED COILS

AT LAST, a manufacturer has introduced coils which are entirely impervious to moisture, as well as being entirely protected against handling, corrosion, etc.

In a recent (Continued on page 424)

Fig. C  
The additional dial above the main one projects the station location and frequency.

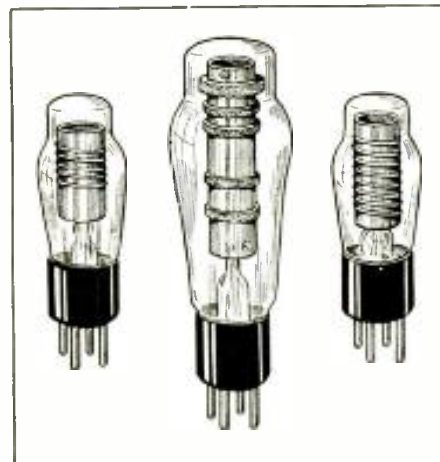

Fig. D  
The appearance of the coils enclosed in glass and evacuated to prevent deterioration.

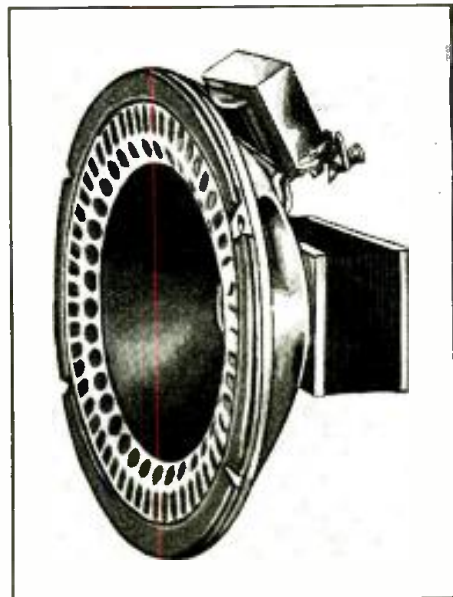

Fig. D  
A bass speaker with special cone support to produce a full floating effect.

Fig. E  
This novel permanent-magnet dynamic speaker has a "tweeter" constructed in it so that it is really two units in one.





# SHORT WAVE PICTORIAL

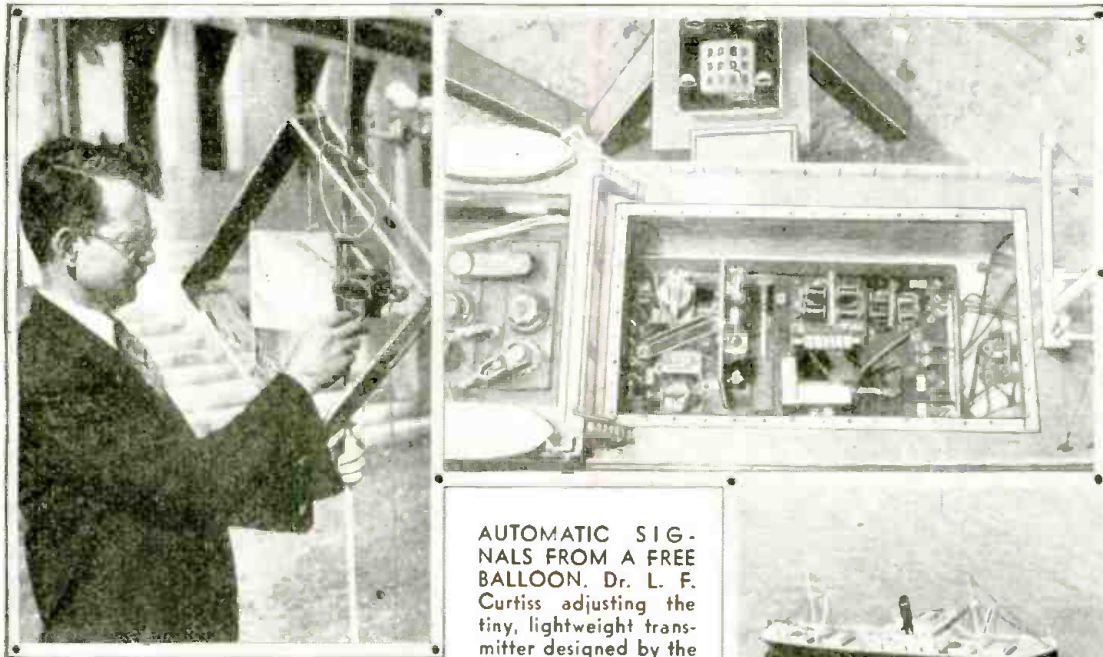

← **RADIO-CONTROLLED MODEL BOAT.** Felix La-Vallee, a Minnesota farmer, built this boat which he operates on a nearby lake. The controlling board of the ship is shown at left. The boat can be started, stopped, or turned by tapping the key.  
(World Wide Photos)

**AUTOMATIC SIGNALS FROM A FREE BALLOON.** Dr. L. F. Curtiss adjusting the tiny, lightweight transmitter designed by the Bureau of Standards to

be used in conjunction with the Weather Bureau in Meteorological experiments. Tests have been made which show that this equipment, which weighs less than 2 lbs., can be heard at a distance of 80 miles, and as high as 14 miles. The transmitter operates on 5 Meters.

(Harris & Ewing)

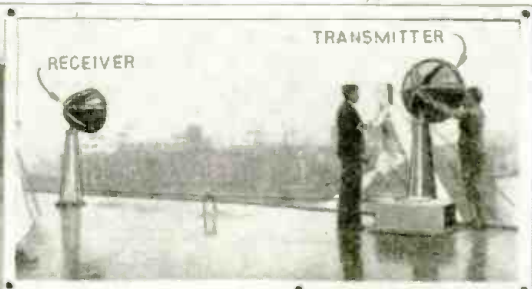

← **MICRO-WAVE OBSTACLE DETECTOR.**

The new Normandie uses this equipment, which operates on a wavelength of 6 ins. A powerful transmitter sends out the waves which are reflected back to the receiving antenna, if they strike any obstacle. The 2 reflectors move together, and may be turned to an angle of 45 deg. on either side of the ship. At the left, the operator is adjusting the wheel which turns the reflectors. The apparatus is located on the bridge, not in the radio room. The equipment is very effective, since the micro-waves are not affected by fog, rain, or other weather conditions.

→ **RADIO USED BY FOREST SERVICE.**

This tiny 5-meter set is used for portable work. It is battery operated, and contains 2 tubes—a 30 and a 49. The circuit is very similar to that used by many amateurs.  
(U. S. Forest Service photo)

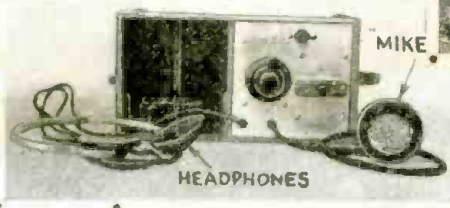

→ **MOST POWERFUL 6.9 METER STATION.** The Berlin television station uses the transmitter, which has a power of 16 kw.



← **AUTOMATIC DEVICE SUMMONS FIREMAN FROM HOME BY RADIO.**

← **RADIO SUMMONS PARIS FIREMEN.**

An automatic device has been installed in the homes of Paris firemen which calls them in case of fire. The transmitter is placed in the firehouse. The system is also in use in the town of Asnieres, and is highly successful.

(Globe Photo)

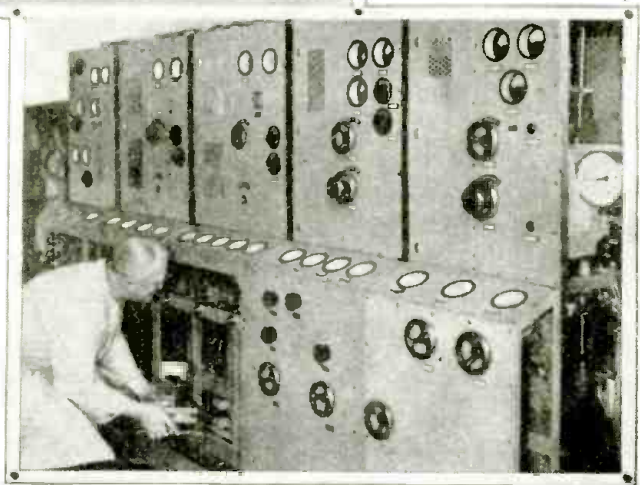



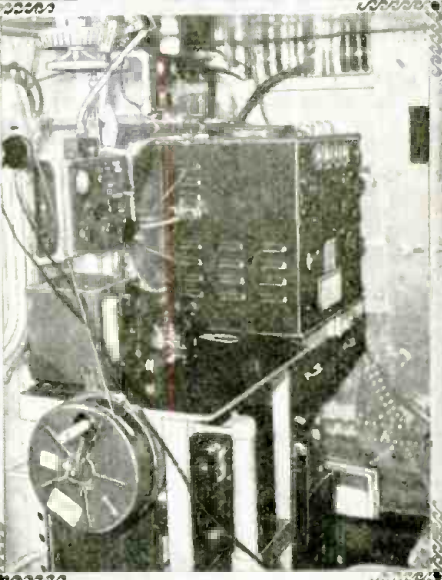

# Radio Views of the News

**BROADCAST SIGNALS GUIDE PLANE.** Above, and right, Ray Brown, with equipment that guides the "General Tire" plane via broadcast-station signals. (TWA Photos.)

**A NEW LOOP ANTENNA.** A new antenna arrangement that circumvents static due to impinging dust and rain at high speeds. (TWA Photo)



**COAST GUARD AIRCRAFT RADIO EQUIPMENT.** The latest type of amphibian is fully radio equipped with transmitting receiving and beacon units as shown above and at left. (Arnold Photos)

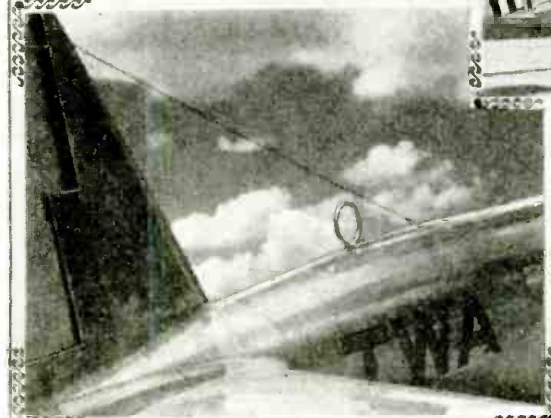

**DIRECTION FINDER.** This double-loop unit makes it possible to guide an airplane by signals from any transmitter. The course is shown in degrees, as is any deviation therefrom. (LeMan Photo)

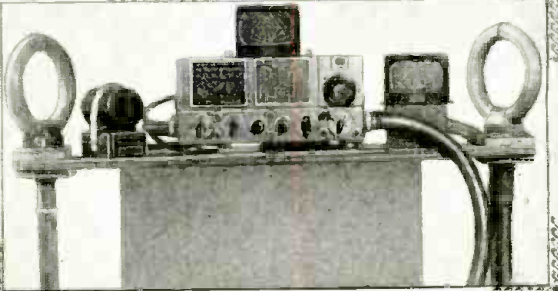

**SECOND SMALLEST TUBE SET.** This tiny 1-tuber was shown at the Olympia Radio Exhibition in London. It contains probably the smallest multi-element

1-tuber made. It is interesting to note that a still smaller set, built by C. W. Palmer, was featured in *Radio-Craft* for September, 1935!



**MONSTER TUBES.** "Miss Radio 1935," at British show, with tubes designed to show complicated interior construction. (Fox Photo)



**HOME RADIO INSTALLATION USES WALL FOR Baffle.** This set, installed in the walls, is enclosed in a metal case. Above is shown the front appearance of the equipment, which is attractive and entirely out of the way. The front plate is finished the same as the wall. At the right, the rear view of the set is shown. The metal cabinet affords complete protection. Back-pressure is prevented by the square hole in the door, the hole being covered with silk to keep out dust. Use of the walls for a baffle provides very fine tone. (Halbran Photos)

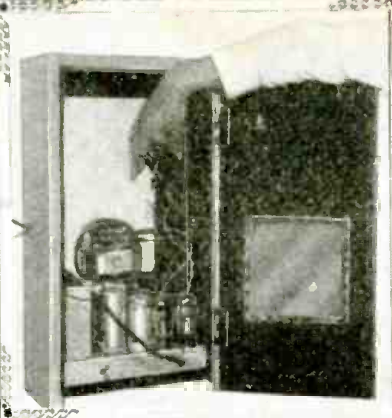

**RADIO IN MANUFACTURING.** This equipment is used in the manufacture of rotary compressors. After being measured to the 1-100,000 part of an inch, this radio equipment gives the final check on these important parts. As the part is revolved around the concentric stud, the tone, heard in the headphones, changes if there are any irregularities. (Crosley Photo)



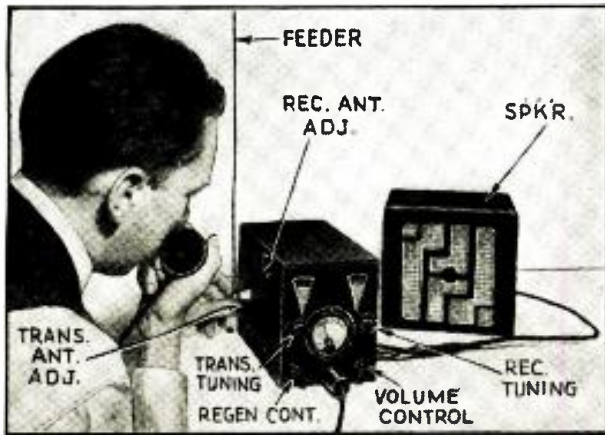

# HOW TO MAKE A COMPLETE 5-METER PORTABLE STATION

Here is a real 5-meter transmitter and receiver for mobile and portable use. It is compact and efficient. Uses 1—955 "acorn" tube, 1—"RK-34," 1—41, and 1—79.

HOWARD G. McENTEE

**H**ERE is a 5-meter set which is designed for any type of portable use. It may be used in a boat, as pictured on the cover, as a car set (as it has been used mainly), or as a portable set with batteries to be used on hikes or other trips where it may be carried as a pack. It uses the very latest high-frequency tubes (including a 955 "acorn"-triode detector and an "RK-34," ultra-short-wave oscillator) and advanced design, and for this reason is highly efficient.

From the circuit, Fig. 1, it may be seen that the device is not a "transceiver," but rather a separate transmitter and receiver with a common audio system. One might think that such an arrangement will cause feedback and other troubles, but such is not the case. Indeed, by using 2 antennas, and taking proper precautions to prevent acoustic feedback between "mike" and speaker, duplex operation is entirely possible, and has been used many times. However, the relay change-over system as used in this set is simple and very fast in operation—so much so, that break-in can be worked as easily as duplex, without any of the feedback and detector blocking of the latter!

## PRELIMINARY PROCEDURE

The set is quite simple to construct, although it must be admitted there is a lot of work to it. The first job is to cut and bend the subpanel to fit the box. The edges of the subpanel are bent

down for 3/8-in. all around, to give strength and provide a means of fastening to the box itself. The 5 x 6 x 9 in. box is a standard size, so a layout (not to scale) of the box is given showing locations of parts on the side and front. It is advisable to cut the holes in the front of the box first, after making sure the parts will fit as shown. Then with the panel equipment temporarily in place, the parts may be placed and marked on the sub-panel. It is strongly recommended that the layout shown in the interior photos be closely followed.

The change-over relay is a special item which fortunately can be procured ready to use. The relay shown was made from the parts of the original, but mounted on a smaller base. In the layout shown, this remounting is unnecessary, the relay being used just as it comes. It may be mentioned here that for some reason the manufacturer provided 4 moving contact arms, but the adjacent arms are not connected together, one arm of both top and bottom pairs being "open." They must be connected in pairs so that the relay becomes, in reality, a double-pole double-throw switch.

A sensitive microphone, and one of low resistance, is needed to pass enough current to operate the relay on the 6 V. filament battery. Such microphones are to be had for a reasonable outlay. (The writer made up a neat hand microphone by fitting a lapel-type "mike" into an earphone case, as shown

in Fig. A—the heading illustration; a push-button was set into the side of the case.) The 500 ohm relay drops the voltage applied to the low-resistance unit to a safe value. The relay winding and condenser C7 also serve to filter the microphone circuit, and to prevent a ripple from the power supply (which sometimes causes trouble).

## FUNCTIONS OF THE TUBES

The input circuit of the 955 detector is of the high-"C" (high capacity) type, which gives best results with this tube. It is a simple matter to get well within the 5-meter band with this system, no cutting of coils being necessary. The small compression condenser, C4, will be used at a rather high capacity setting.

The cathode bias resistor of the 41 tube is of high value to reduce the plate current somewhat, since the full power output of this tube is not required and we wish to conserve plate current as much as possible. The 79 tube works as a conventional class B amplifier.

The RK-34 is a dual tube something like the 6A6, but having lower amplification factor. Thus it acts as a conventional tube, the plate current increasing as it is loaded up, and not the opposite as with the 6A6 or 53. Also, it is designed for high-frequency work, and does its job beautifully. The usual "T.N.T." (capacity-tuned—C12—plate, and inductance-tuned grid) circuit is used and the (Continued on page 424)

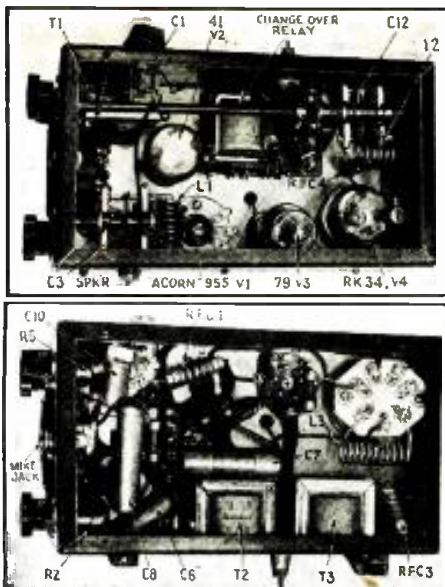
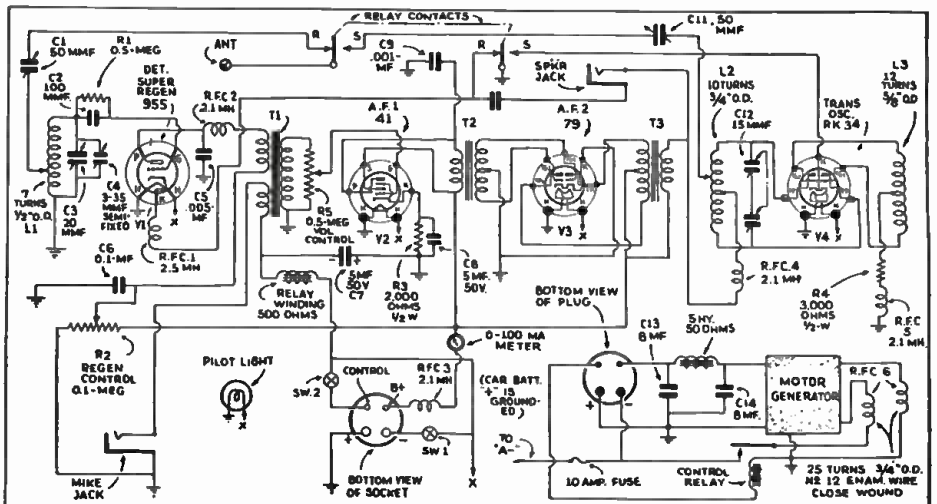

Fig. 1, below. The schematic circuit of the transmitter and receiver—a common amplifier is used for both. Fig. B, left. Interior of the cabinet from the top. Fig. C, lower left. Interior of cabinet under chassis.





# MAKING A TUNED ALL-WAVE ANTENNA

A tuned coupler for doublet antennas improves results on frequencies remote from the aerial resonant frequency.

J. B. CARTER

**I**N CONNECTION with all-wave antenna systems there has been published so much misinformation and the matter has been further complicated by so much technical vernacular that the average person is frightened by the mass of mathematics and the apparent complexities such an installation would involve.

While it is almost impossible to

achieve 100 per cent efficiency with any type of antenna, the doublet antenna, properly constructed, is far superior to any other when used for short-wave reception. Some doublet systems, however, while reducing noise also reduce signal strength, because they depend too much upon aperiodic effects and omit all tuning devices. This is not the best practice as the disparity in sensitivity in the various bands is too great. For maximum efficiency over the entire range of short waves, antenna-circuit tuning should be included as a vital part

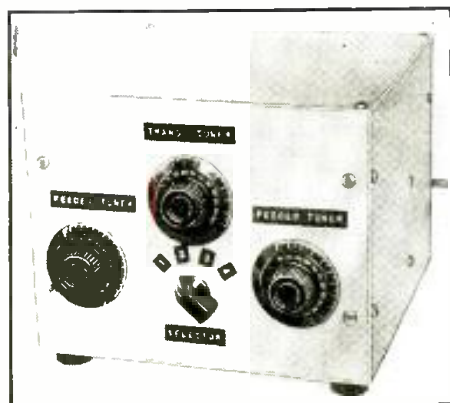

The external appearance of the doublet coupler.

of the installation.

The doublet or dipole antenna consists of 3 parts, namely, (1) the aerial, (2) transmission line, and (3) matching transformer. The aerial or "sky wire" is the collector of short-wave

(Continued on page 425)

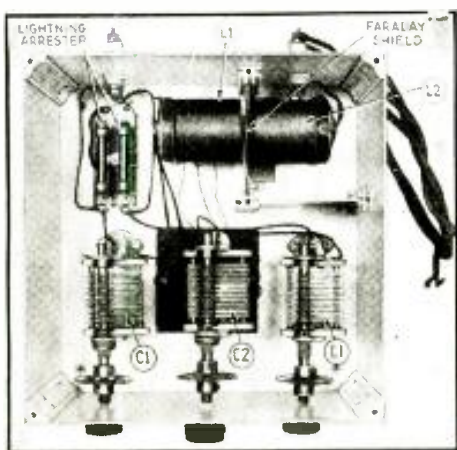

Left, the interior of the shield can, showing the position of the electrostatic shield which eliminates capacitive coupling between the coils. Right, Fig. 1. Circuit (A) and details (B and C) of coupler.

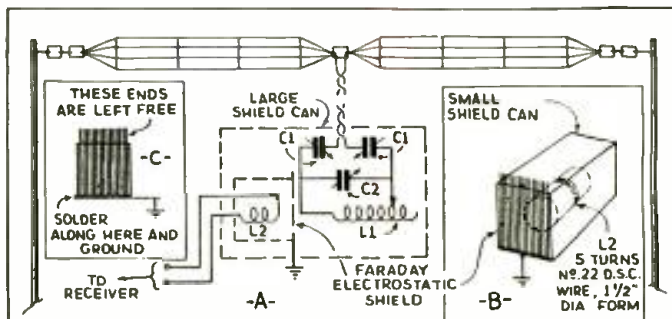

# A 5-METER ANTENNA DIRECTIVE-BEAM ARRAY

Directive antennas for ultra-high frequencies are finding important uses for both transmission and reception.

SAMUEL M. WERTHEIMER\*

**T**HE LONGEST reliable transmission range of ultra-high frequencies is limited by the quasi-optical nature of these short waves. They include all frequencies from about 40 mcs. (megacycles) and higher, and all wavelengths of (about) 7½ meters or less. Due to the characteristics of these frequencies, they are not reflected by the Heaviside layer, although records do show that signals have been received over many times the reliable quasi-optical range.

\*Birmingham Radio Co., Inc.

Fig. 1. The position of the radiators and reflectors used in the beam array.

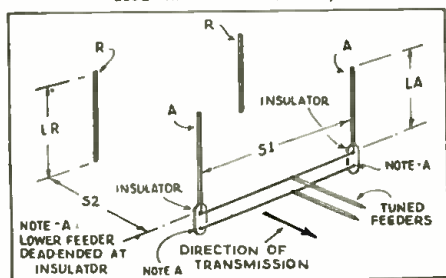

Increased operating range is noticeable at night. The normal dependable communication range which is due to the bending of the wave around the curvature of the earth, is about 10 per cent greater than the optical range or

$$1.34 \sqrt{h_t + h_r}$$

where  $h_t$  is the effective height of the transmitting antenna and  $h_r$  the height of the receiving antenna. Reliable communication is sometimes maintained for distances up to 200 miles when conditions are favorable.

Antennas having well-defined directivity have been widely used for transmission and reception since 1888. Hertz revealed their effectiveness even before that date! Commercial interests have applied these principles for years as shown by the great variety of shapes of directive antennas in use. It is relatively inexpensive, and increased range and reliability are the advantages gained by transmitting with a properly constructed "directive beam antenna."

(Continued on page 426)

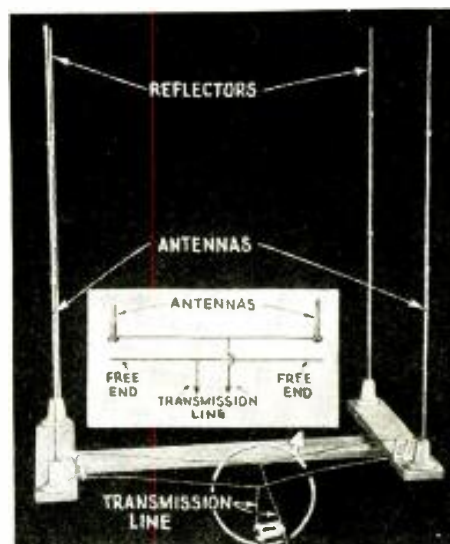

Appearance of the beam antennas and reflectors.

Fig. 2. Wave patterns, showing the action of the parasitic reflectors on service area.

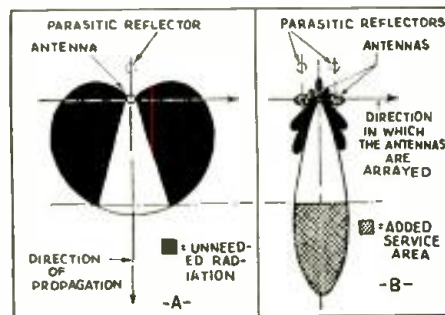





# TELEVISION AND THE ULTRA-SHORT WAVES

The entire future of television depends on the "micro-waves," below 10 meters.

WILHELM E. SCHRAGE

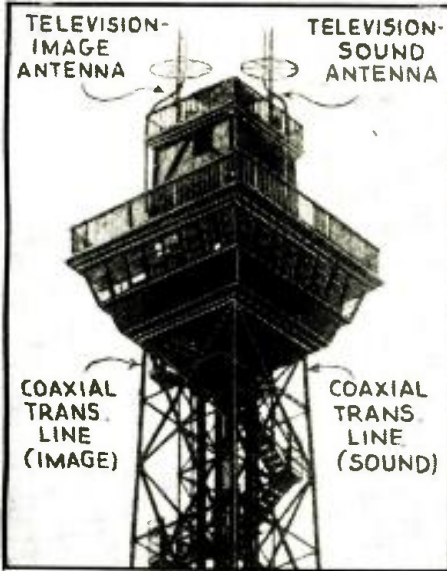

Fig. A. The Berlin television transmitter aerials.

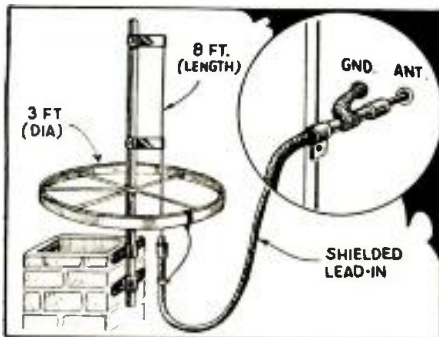

Fig. 2. Receiving antenna and counterpoise.

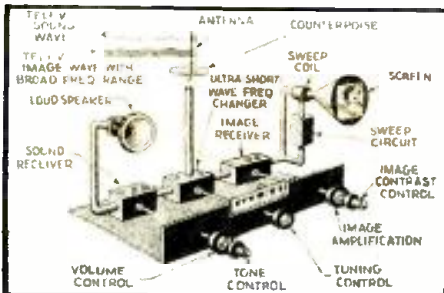
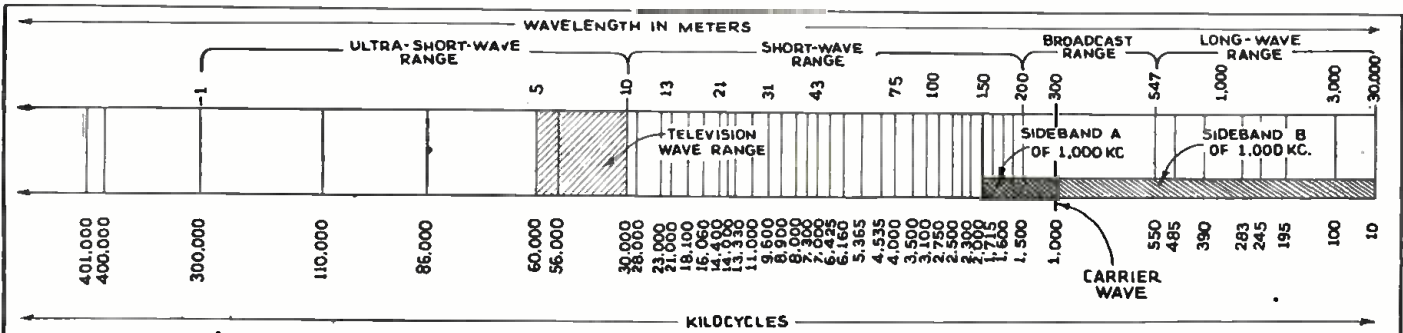

Fig. 8. Block diagram of single dial control.

Fig. 1. The comparative width of a television band on short vs. long waves is indicated in this chart.



**D**ESPITE the fact that the fundamentals of television technique were invented some 50 years ago, and despite the fact that tremendous strides have been made, especially in the last few years (see, "World-Wide Television," August 1935 special Television Number of *Radio-Craft*—Editor), there would not be the slightest basis for thoughts of high-definition television today if ultra-short waves were not available.

This may at first sound strange and exaggerated, since everyone knows that actual television transmission was accomplished about 10 years ago, at a time when the production of short waves in the range of 1 to 10 meters was simply an interesting experiment having only theoretical value.

### PAST AND PRESENT IMAGE CLARITY

That is, of course, correct, but we should not forget that television transmission in those days could not be compared with the high-definition performances obtained today. One might readily say that the 30-line television transmission of 1928 may be compared to the 180-line transmission of today, as that of a rough illustration printed on pulp paper to a first-class photograph reproduced in a smooth-paper publication.

The public saw in those days not television in the real sense of the word, but only moving shadows, and if some radio listeners (induced to buy a television receiver by misleading advertisements during those times) are biased today against television, no one can blame them.

Today the situation is quite different. (See "A Modern Picture of Television," Parts I and II, April and May (respectively), 1935 *Radio-Craft*—Editor). The tremendously improved television technique provides a means to reproduce in the home of the listener

actual clear images, rich with details, and offering as much entertainment value as obtained, for example, through the use of a good home-movie projector.

The newly obtained clearness of image reproduction would never have been possible if television engineers had been obliged to transmit the necessarily large number of television image impulses by means of radio waves of the same length as are used for sound broadcasting.

The clarity of a television image increases in about the same degree as the number of picture elements is increased. What this expression "picture elements" actually means, and what technical problems are involved by application of a large number of picture elements for television image transmission, may be better understood from the following explanation.

Most of us have seen in churches the large pictures (consisting of tiny squares made of glass or stone) called "mosaics." The smaller the size of the tiny squares (and consequently, the greater their number), the more details can be recognized.

The same condition applies to the entertainment value of a television picture. The smaller the picture elements reproduced, the clearer the image and the more details may be seen. But there is a vast (Continued on page 428)

Fig. 3. A revised autodyne mixer and dual I.F.

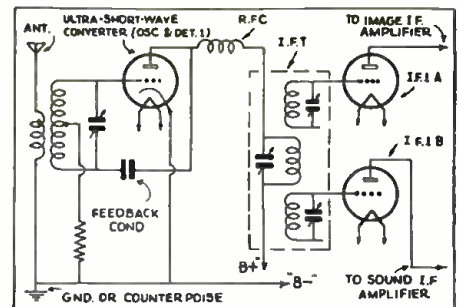



# A 3-TUBE "SINGLE SIGNAL" S.-W. SUPERHETERODYNE

Double regeneration makes this A.C.-D.C. and battery 3-tube set the equivalent of one using several more tubes.

McMURDO SILVER\*

**R**EGENERATION is the oldest known method of "getting something for (relatively) nothing." Regeneration applied to a single tube will yield sensitivity limited only by its degree and stability—which is simply another way of saying that in the matter of sensitivity alone, a regenerative detector will give all that can be had from multi-tube "repeater" amplifiers.

On weak signals the selectivity of a critically regenerative detector will be good, but it will not be good on strong signals, nor is it really satisfactory for amateur, let alone broadcast, use, due to the poor selectivity of the best available single tuned circuit even when aided by regeneration.

If selectivity, or the major portion thereof, can be had through several good tuned circuits, then regeneration can simply and economically contribute to valuable, added selectivity, ordinarily difficult to obtain.

Going from the general to the specific, the "Super-Gainer" described herewith, using only 3 tubes, provides all the sensitivity and image selectivity any amateur can desire, and through non-critical I.F. regeneration practical, simple and fool-proof single signal C.W. selectivity on C.W. reception.

Conceived by Frank Jones, technical Editor of "Radio" from the original 1932 revelation by McMurdo Silver of the use of regeneration to obtain single-signal C.W. selectivity, the "Super-Gainer" has been designed by these two competent authorities. For no more than the cost of a 3-tube ("one R.F., regenerative detector and one (Continued on page 427)

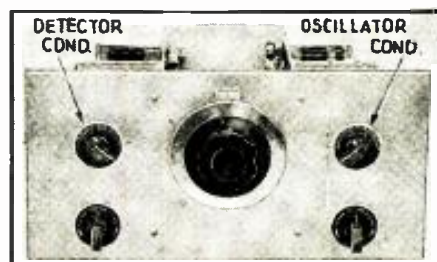

Above, pleasing front panel appearance of the super.

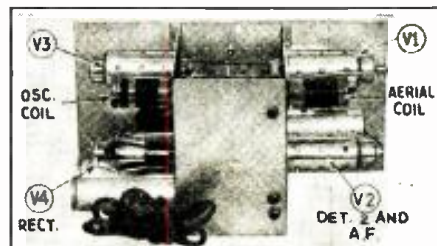

Above, rear view showing the unconventional, but efficient construction. Below, Fig. 1, the diagram, with power supply for A.C. use at B.

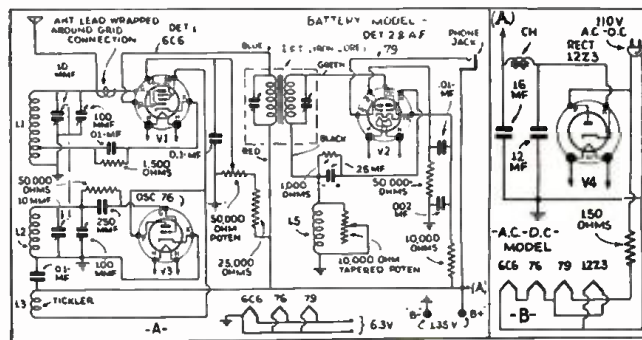

\*McMurdo Silver Corp.



The rear view shows how compactly the batteries fit the cabinet. Below, Fig. 1.

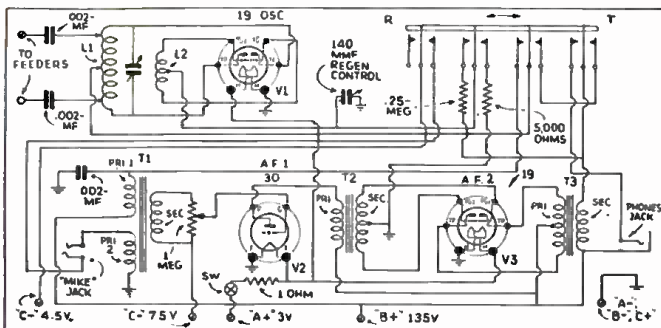

## A COMPLETE 5-METER TRANSCEIVER "STATION"

A self contained outfit which can be operated anywhere. Many miles can be covered under favorable conditions.

J. T. BERNSLEY\*

**T**HE SIMPLICITY of construction, and extremely high efficiency of both transmitter and receiver of this unit will delight any amateur. It was designed not only for amateur transmission and reception, but is ideally suited for commercial use, especially where satisfactory operation is required under practically any conditions.

While it is apparent to most short-wave men, particularly amateurs, that somehow most portable 5- and 10-meter transceivers seem to be physically alike, the explanation for it may not be so well understood. Present day requirements for an instrument of this type are the chief factors for the practically universal adoption of the metal "can" or housing which is the cause of this seeming coincidence. The physical dimensions, construction and attractive appearance of the case make it admirably suitable for transceiver purposes. However, from this point on the similarity ceases, since practically every individual manufacturer of this type of unit employs his own pet circuit or design.

The circuit, constants and parts layout for the transceiver shown in Fig. 1, were arrived at after building several models and considerable experimentation. The usual difficulties encountered in attempt- (Continued on page 426)

\*Try-Mo Radio Co.



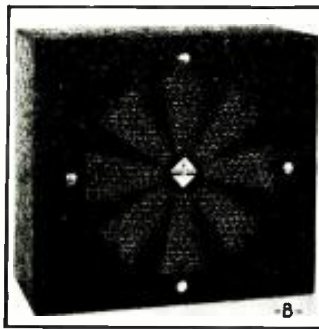

## REPRODUCERS FOR USE IN S.-W. RECEIVERS

Details are given for the selection of the best type of reproducers for your short-wave set; important factors are noted.

D. H. WRIGHT\*

**T**HE TESTS of the speakers illustrated were made at the short-wave receiving station of Doctor George W. Twomey of Minneapolis, Minn. This station is equipped with the best possible types of receivers, all of which were used in the tests. The antenna was a  $\frac{1}{2}$ -wave, 25-meter doublet designed by the Doctor. The antenna is made of  $\frac{1}{4}$ -inch copper tubing such as is used in electric refrigerators instead of the conventional No. 14 or 12 solid or stranded copper wire that is ordinarily used. (The pick-up from this antenna is remarkable and the cost of the copper tubing is not a great deal more than copper antenna wire.)

Realizing that an article on short-wave reception, written by Dr. Twomey in his own manner should be interesting to short-wave fans, we have prevailed upon his good nature to write the short article which follows:

The choice of a reproducer for short-wave reception is a matter of importance. This is true with many owners, first, because of the cost which is a factor favoring the use of the dynamic speakers illustrated, and which tests have proven are particularly efficient for short-wave reception. (One is priced at an extremely modest price, while the other is in the medium-price class.)

\*Wright-DeCoster, Inc.

It should be remembered that short-wave reception is not the same as reception on the broadcast band. A speaker which gives satisfactory broadcast-band reception may be very poor on short-wave reception, and a good short-wave speaker may not perform equally well on the broadcast band. The reproducers discussed have been designed particularly for short-wave reception but have also been found to be quite satisfactory for broadcast-band reception.

### "SENSITIVE" REPRODUCERS NECESSARY

Short-wave programs are usually received from very low-powered short-wave transmitters many thousands of miles away, and often through atmospheric disturbances and heavy static. These factors make it essential for us to have a speaker of the highest efficiency and of such design that a minimum amount of noise is reproduced if the best short-wave reception is to be enjoyed.

The speakers were first tested for A.C. hum, a defect that is often fatal to satisfactory short-wave reception. With the model shown at B in the leading illustration a faint hum could be detected at a (Continued on page 425)

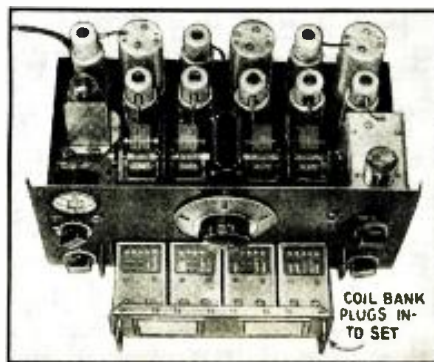

A very efficient high-frequency receiver.

## METAL TUBES AND THE NEW S.-W. RECEIVER

A few of the problems which have arisen since manufacturers adopted metal tubes are discussed by Mr. Millen.

JAMES MILLEN

**I**T IS PROPHESED that 1935 will go down in radio history as the year of the adoption of metal tubes. They represent such a definite advance in tube design that they cannot be ignored. However, they present a problem as well as an opportunity. The opportunity is obvious; they are completely shielded, small in size, have short leads, and have small interelectrode capacity. They thus permit the construction of stable, high-gain sets. The problem is how to take advantage of their properties.

This is not as easy as it sounds. Leads must be short outside the tube as well as inside, shielding must be complete everywhere, stray capacities must be kept down. These requirements can be met by careful arrangement of parts,

if plug-in coils are used, and if electrical efficiency is put before the operator's convenience. But when these requirements are combined with knob-controlled multi-band operation, the trouble begins. The coil switch of a year ago simply will not do. If one is to have short leads, each coil must be close to its condenser section. Tapped coils are compact but inefficient; individual shielded coils take up too much room. And no matter how we crowd the coils, the switch still occupies the coveted position next to the condenser, for obviously the coil and condenser must be wired to the switch, not to each other.

Every manufacturer will doubtless find his own solution, but we found that to do the job right it would be necessary to start fresh and find a radically different way of shifting coils. And since a completely new design was thus (Continued on page 425)

### TABLE I

- 1) All R.F. leads must be short, which means that each coil in use must be close to its tuning condenser and close to its tube.
- 2) Each coil must have its own individual shield, to eliminate stray fields.
- 3) Each coil not in use must be removed completely from the circuit to eliminate dead-spots due to absorption of R.F. energy. Dead spots usually do not cause the manufacturer much trouble, because when a broadcast listener cannot pick up a transmitter he wants, he usually blames it on the weather, or his location, or something. But when receivers are designed for communications companies, bluffing does not "get by."
- 4) Shifting must be accomplished by a knob—on the panel, for convenience.
- 5) Shifting must be exact, for calibration. Tuning the signal in and out by wiggling the coil-range knob is no good; calibration must be exact and permanent, with no "ifs."



# A 5-TUBE A.C.-D.C. "TURRET" ALL-WAVE SET

Metal and glass tubes are combined in this set which is designed especially for short-wave fans.

H. G. CISIN

**P**LUG-IN COILS for efficiency—switching arrangement for convenience; that is the usual rule for all-wave receivers, but every rule has its exception. Here is an excellent all-wave receiver which employs standard plug-in coils in a unique switching device whereby a twist of a knob swings the desired coil into the correct functioning position, eliminating the long leads and consequent losses found in ordinary switch arrangements but retaining all the conveniences. The device permits 4 coils to be plugged in at once so that the set can be used to cover 4 desired bands without any necessity for changing coils. This receiver incorporates a circuit combining one of the new metal tubes (V2) with glass tubes, as follows. Since this circuit employs a regenerative detector, V2, which requires very good shielding for best performance, the use of a metal tube as V2 results in much better performance than when a shielded glass tube is employed. The improvement is especially marked on short-wave reception.

The first stage constitutes an *untuned* R.F. amplifier using the type 6C6 tube. This tube is coupled to the metal 6J7 regenerative detector by means of impedance coupling, involving the use of a 2½ mhy. R.F. choke, R.F.C., as the primary, and the longer winding L2, of the plug-in coil as the tuned secondary; the shorter winding, L2, of the plug-in coil is used as a tickler (feedback) inductance.

A coupling condenser C4, adjustable by means of a screwdriver as the final set adjustment, couples R.F.C. and L1.

Condenser C5 tunes coil L1. Additional vernier adjustment or "band spreading" may be secured by shunting a 50 mmf. condenser (C6) across C5.

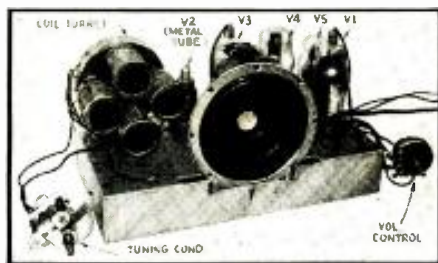
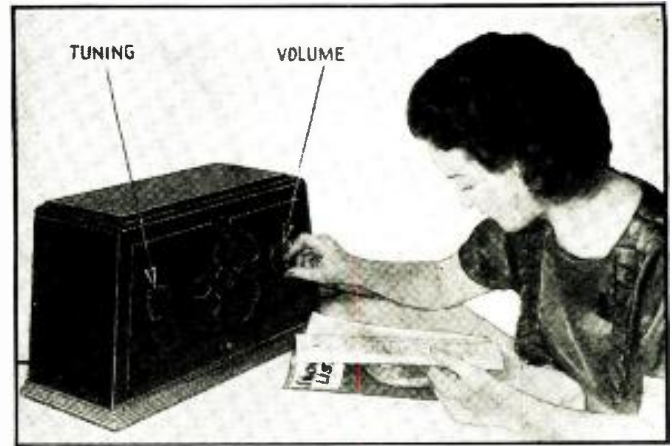

Fig. 8, left. The positions of the coil turret, speaker, tuning condenser and volume control are shown in this photo.



The receiver in operation. Two knobs controlling tuning and volume (regeneration) appear on the front.

Potentiometer R6 controls sensitivity and volume (regeneration) by varying the voltage on the detector plate from zero potential to a maximum of about 100 V.

The two stages of A.F. amplification employ resistance coupling. Mica-dielectric condenser C14 filters out some of the treble, giving preponderance to the bass response and thus improving the tone quality; use a value for C14 as determined best for a given reproducer.

Provision is made at J1 and J2 for headphone reception. If it is desired to cut out the reproducer while listening-in with the headphones, insert a switch in the secondary circuit of output transformer T, at "X," as shown.

Rectifier V5 provides rectified current both for the speaker field and for the plates and grids of the tubes in the set.

The set is constructed on a metal chassis 11 x 6 x 2 ins. high; speaker, choke Ch., and the coil-changing "turret" mount on top. Controls R6 and C5 are mounted on the front panel of the cabinet. Twin phone jacks J1 and J2, and antenna trimmer C1, are fastened to the rear chassis wall. All other parts are mounted beneath the chassis.

In assembling the chassis, the potentiometer and variable condenser are connected at the ends of flexible leads which extend 4 or 5 ins. from the chassis so that they can be fastened to the cabinet panel without difficulty after the set has been placed in position in the cabinet.

It will be noted from the schematic diagram that the set is provided with two flexible wires for antenna connections, *in addition to the standard antenna clip* (which is soldered to the end of the antenna trimmer, C1). One of these wires leads directly to the plate of the 6C6 tube, V1. This is used for increasing the selectivity of the receiver when used for ordinary broadcast reception. The second flexible wire is connected to the other side of C1, or in other words, directly to the cap of "V1" and this connection is used for increasing the gain on short-wave reception. For example, a weak foreign station may be tuned in with the antenna connected to the clip and this may be brought out very much louder by connecting directly to the cap of the 6C6 tube, V1.

If the set is wired in accordance with the circuit, it should operate immediately upon being plugged into an A.C. or D.C. line. It is best to start test- (Continued on page 429)

The circuit of the set showing the way in which wires are brought out for improved selectivity and gain on the various wave-bands.

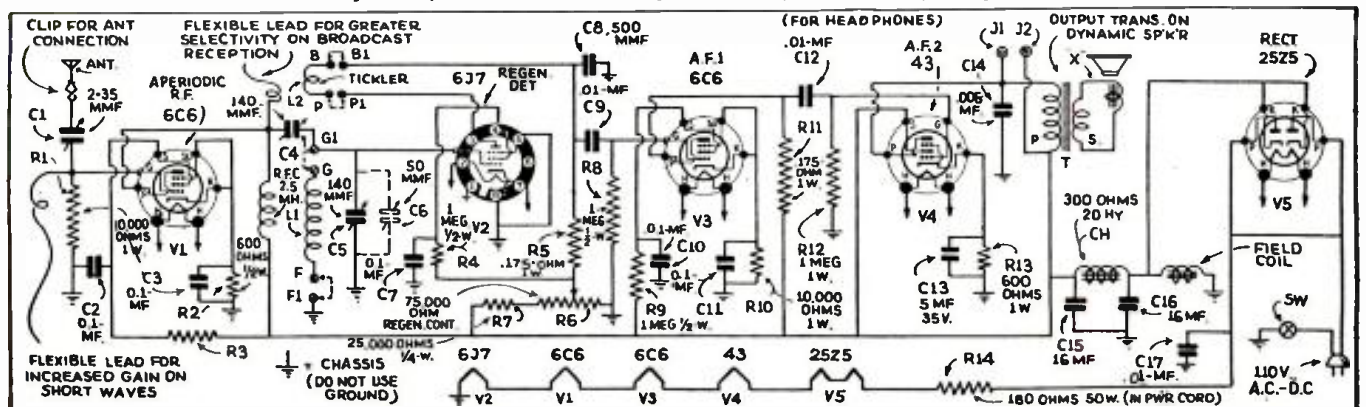



# ANALYSES of RADIO RECEIVER SYMPTOMS OPERATING NOTES

## KOLSTER K43

WHILE trouble shooting on a Kolster K43, I received a shock as I replaced the antenna lead on its binding post. On inspection, I found the aerial wire down, and lying across a neighbor's ground wire. After the aerial was removed from the ground wire the set still refused to work. The second R.F. grid circuit was found to be open, and upon repair the "radio" worked correctly. See Fig. 1A.

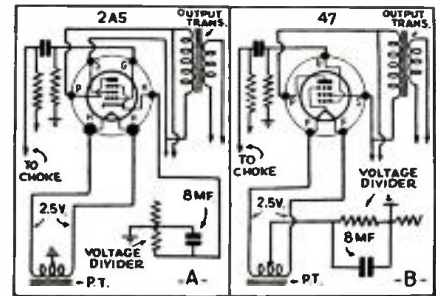

Fig. 2. Changing the output tube.

## KOLSTER K22

EXCESSIVE regeneration in these sets may be overcome by adjusting the two hum balancers. Regeneration had appeared after installation of a new set of tubes.

## AMERICAN BOSCH 96A

A LOOSE driving rod on the magnetic speaker of these sets often gives rise to a complaint of weak and distorted reception. The repair is effected by soldering the rod to the cone.

## CROSLEY 706

NO PLATE VOLTAGE on the first A.F. tube (type 26) in this set was traced to the spring contact of the socket, which did not make contact with the tube prong. A slight bend fixed this up.

## SIMPLEX MODEL R

THE customer complained that the set smoked. The trouble was found in the power supply, where the 4 mf. condenser was shorted.

## CROSLEY 124

INTERMITTENT, noisy reception in a Crosley 124 was cured by the installation of a new 5,000 ohm volume control.

## STEWART-WARNER 202A

THE set was reported dead. Analyzer reading showed no voltage on the screen-grids of the first-detector (24) and I.F. (35) tube. See Fig. 1C. The 6,000 ohm screen-grid supply resistor tested open and was replaced.

## BOSCH 58

THE SET was dead, and on analysis showed no grid bias on the first A.F. tube (27). The 2 meg. coupling resistor, shown in Fig. 1B was replaced with a 1 meg. unit, and the set came to life. On this same set, the phosphor bronze drum-dial cable had been replaced twice in a short time. Each time it had been replaced with the original bronze cable, but this time I installed steel pulley cable, consisting of 16 strands of fine steel wire (this cable is used on some auto control systems). This overcame the trouble, and whenever I have this trouble of persistent cable failure, I always replace with the steel material.

## SERVICE "BRIEFS"

G.E. T-12. The reception of a General Electric Model T-12 (4 tubes) was improved by increasing the length of the aerial from 50 to 100 ft.

Sonora 47. Noisy reception at the high end and no reception at the low-frequency end of the dial was traced to shorted tuning condenser plates.

Zenith A. Tom Thumb P45. Halson 515SW. Intermittent hum in these sets was cured by replacing the filter condensers in each case.

Phileo 470. Intermittent hum and reception were the complaints. The power switch had to be snapped on and off several times to start reception. The A.F. coupling condenser, shown in Fig. 1D, was shorted. No reception on the 2nd and 3rd band of this model was due to poor band-switch contacts.

Phileo 511. Lack of detector plate voltage in this set was due to an open 70,000 ohm detector plate-supply resistor. This was replaced with a new unit of 75,000 ohms. See Fig. 1E.

Clarion A.C. 40. Excessive hum was

(Continued on page 430)

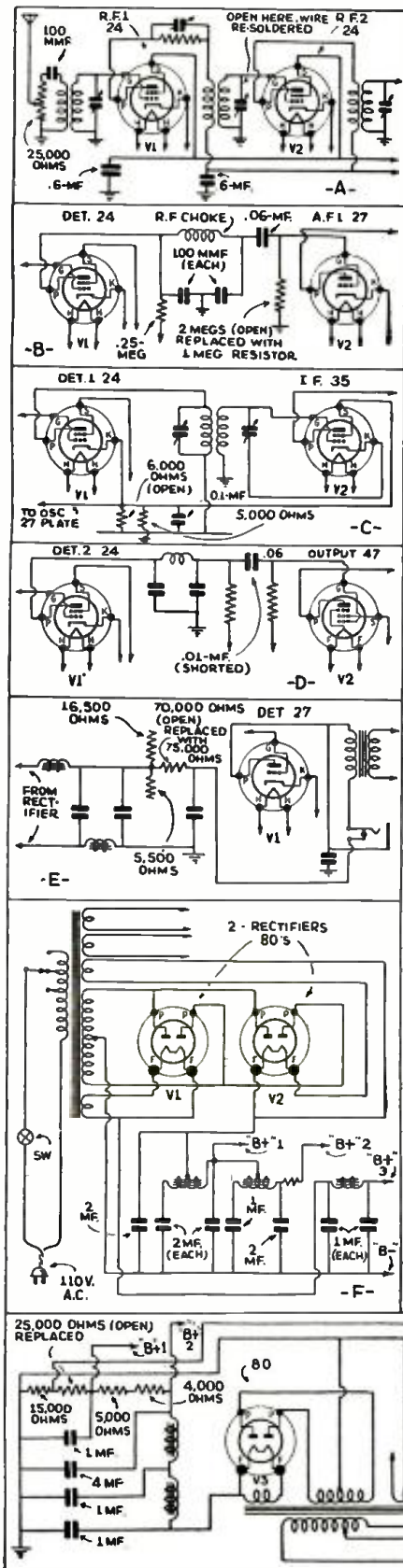

Fig. 1. At left and below, a series of service notes on various sets.



# CHOOSING THE I.F. FOR ALL-WAVE SUPERHETS.

The reasons for the trend to higher intermediate frequencies in the latest sets is discussed in this article.

ALFRED A. GHIRARDI\*

**S**MART SERVICE MEN make it a habit to acquaint themselves as soon as possible with all the circuit and construction features which are incorporated in the latest receivers offered to the public, so that they may prepare and equip themselves beforehand to meet any new servicing problems which these sets may later present. If you will check over the specifications of some of the many new sets on the market this season, you cannot help but realize that there is a definite trend toward the use of higher intermediate frequencies in the new all-wave sets.

Only a few years ago, when the *standard broadcast receiver* having a tuning range from 555 to 187 meters was the popular set in this country, intermediate frequencies

\*Radio and Technical Publishing Co.



Fig. 1. This chart shows pictorially the positions of the various intermediate frequencies used in all-wave sets.

of 125, 130, 175, 181.5, or 264 kc. were most commonly employed. The newest 1936 *all-wave receivers*—having larger tuning ranges covering at least 555 to 16 meters—employ much higher I.F.s, or frequencies somewhere between about 456 and 472.5 kc. The difference between these two design practices is illustrated graphically in Fig. 1. Is this new trend just another whim of circuit designers, or are there sound technical reasons for the change? Let us see!

It is necessary that a high I.F. be employed in a receiver in order to minimize "image frequency" interference. This is even more important in short-wave reception than it is for standard broadcast-band signals. (It is a well known fact that the frequency of an interfering "image" signal is *higher* than that of the "desired" signal by an amount numerically equal to *twice* the I.F. employed in the receiver.) In order to study the effect of a high I.F. in reducing image-frequency interference, we must consider its effect on both standard broadcast-band frequency signals, and on short-wave signals. Let us consider the effect on a standard broadcast-band signal of 1,000 kc. first.

## BROADCAST BAND SELECTIVITY

At a receiver tuning dial setting of 1,000 kc. and with an I.F. of 175 kc. the frequency of the "image" interfering signal is  $(1,000 + [2 \times 175]) = 1,350$  kc. Now a 1,350 kc. signal differs from the desired (Continued on page 431)

Fig. 2. Actual percentage differences of images when using 2 common values of I.F.

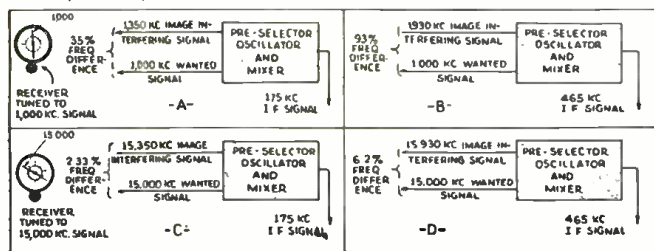

# ALIGNING ALL-WAVE RECEIVERS

O. J. MORELOCK\*

General instructions for aligning all-wave receivers which the reader may apply to almost any set of this type.

**A**LL-WAVE RECEIVERS like their brothers of the broadcast group can and will get badly out of alignment in a comparatively short period of time. Lack of sensitivity due to this condition was not so apparent in broadcast receivers where local reception still continued to be satisfactory. On the short-wave bands the majority of programs having particular fascination emanate from foreign transmitters most of which are 3,000 miles or more distant. As these signals are weak, lack of sensitivity will immediately be apparent by poor foreign reception and dissatisfaction on the part of the owner. By realigning a set in this condition the sensitivity can be increased in many cases several hundred times causing amazing improvement in the operation.

As approximately 95 per cent of the all-wave receivers are of the superheterodyne type, first consideration should be given to the intermediate frequency amplifier as this part contributes most of the gain.

## ALIGNING THE I.F. PORTION

A well-designed test oscillator having

\*Weston Elec'l. Inst. Corp.

constant-impedance attenuation characteristics (such as found in the Weston Model 692) should be connected from the control-grid of the first-detector tube, to the chassis of the receiver. A shorting clip in the form of a piece of metal or a small screwdriver should be carefully placed between the plates of the receiver oscillator gang condenser, thus shorting this unit and causing the receiver oscillator section to stop functioning. The test oscillator should then be turned on, and set to the exact frequency shown on the calibration curve as being the I.F. called for by the manufacturer. It is important that the oscillator be furnished with accurate calibration curves as further alignment of the receiver will be almost impossible unless the I.F. setting is in ac-

cord with the manufacturer's specification. Put the radio set in operation. The oscillator should then be turned on, and the attenuator turned up to a position where a signal is heard in the receiver speaker. The volume control should be placed in the "maximum" position, and an output meter of a copper-oxide rectifier type (Weston Model 571 or 695, or equivalent) connected either from plate-to-plate of the output tubes, or through the series condenser from the single output tube plate to chassis.

If, when the oscillator is turned on, no signal is heard in the speaker and no indication is shown on the output meter, the oscillator control should not be disturbed.

Instead, the (Continued on page 431)

At right, the various condensers associated with a typical superheterodyne oscillator and mixer circuit are shown.

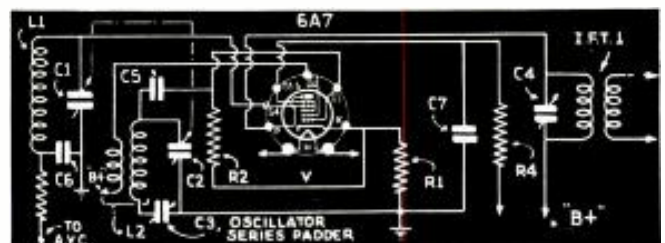



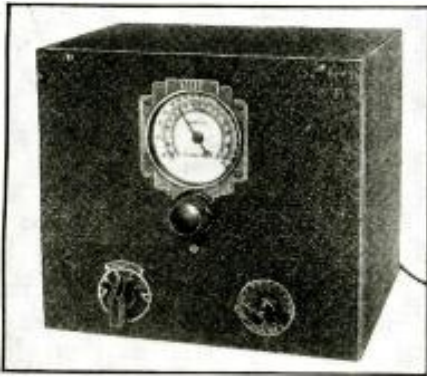

# A SIMPLE 2-TUBE A.C. SHORT-WAVE CONVERTER

The short-wave spectrum from 19 to 200 meters is covered by this simple but effective converter.

ROBERT G. HERZOG\*

**"YOU MEAN** that I can actually hear foreign stations on my own set without buying an expensive all-wave radio set?"

\*Thor Radio Co.

self-powered short-wave converter to your broadcast receiver you may hear these foreign stations as well as police calls with little expense and without affecting the reception of local broadcasts."

It is almost common knowledge that converters can be attached to ordinary broadcast receivers but many believe them impractical because of their own (or their friends') previous poor ex-

periences with "short-wave adapters" and such similar gadgets. However, a self-powered converter of the superheterodyne type will work well on almost any type of broadcast receiver.

The converter shown is built of standard-quality (Continued on page 429)

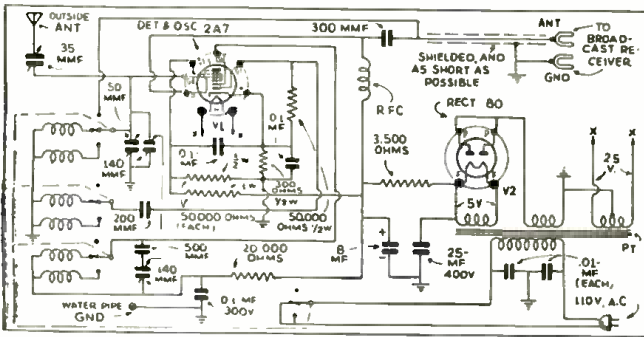

Since the wave-change switch controls the A.C. circuit, and also shifts the antenna, this converter may be left permanently connected to the set. It is entirely self-powered.

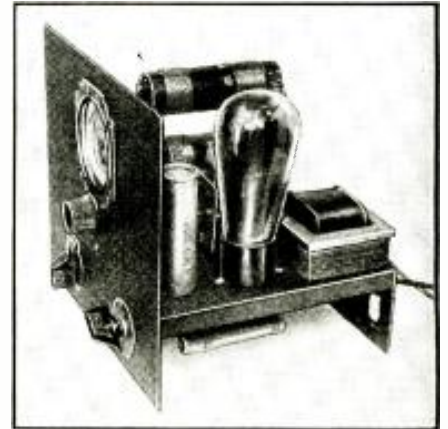

# A UNIVERSAL-CURRENT 1-TUBE ALL-WAVE PORTABLE

This receiver is of the all-wave type and can be used in the home or in the auto. Only one tube is used.

H. A. HARRIS

**T**HE VERSATILE 6F7 has been called upon again in this portable set, to furnish performance equivalent to that obtained ordinarily from 2 tubes. Since the high-voltage batteries are of the small portable type, the drain should be kept as low as possible. A single 1½ V. penlight cell is used for bias of the audio section of this

set, with the result that the total "B" drain is only 4 ma.

Plug-in coils are used so the constructor can cover any bands he wishes. Several means of connecting the antenna to the set are provided, including a variable condenser, to be used for highest efficiency on the short-wave bands. The length of antenna used governs the selection of the proper tap. Some experiment may be needed, but as a rule use as much antenna coupling as is possible, and yet retain satisfactory regeneration.

The cord for connection of filament



The small knob on the end of the case is the antenna condenser.

voltage is reversible. For A.C. use, the 4-prong end goes into the corresponding socket, C, in the set, the other end connecting to the power socket. This connects the filament transformer to the line, and the tube or the pilot light may be turned on at will, each by its respective switch. For use in the car, plug C is inserted into socket B, which has (Continued on page 430)



The novel reversible plug enables this set to be used either on A.C. or batteries. It cannot be inserted the wrong way.

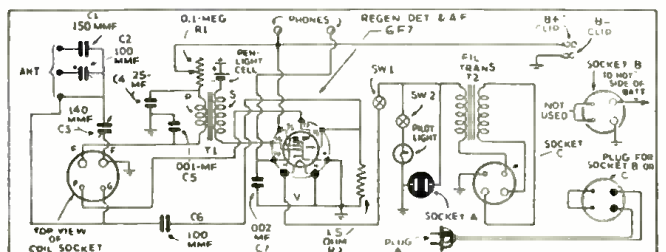



# FOR BEGINNERS— A "4-in-2" A.C.-D.C. SHORT-WAVE SET

This universal-powered plug-in coil short-wave and all-wave receiver is easy to make.

DONALD LEWIS

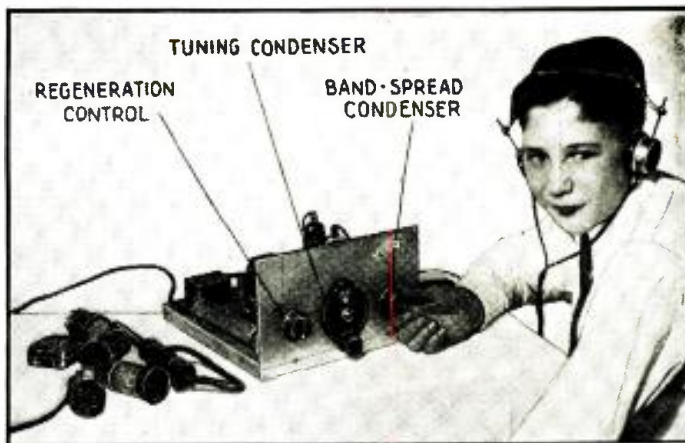

**T**HERE ARE only 2 tubes in this interesting A.C.-D.C. "breadboard" receiver; yet, it has an untuned R.F. stage, a tuned regenerative detector, an A.F. amplifier, and a rectifier. It is perfectly stable, oscillates easily from 200 down to 15 meters, and really provides foreign reception with surprising ease. In fact, during a test, a half-dozen foreign stations were tuned in quite easily and heard on a 5-in. dynamic speaker. When this receiver is used on A.C., the amount of hum is negligible while the receiver is regenerating.

The circuit was evolved around the types 6F7 and 12A5 tubes. The 6F7 is really two tubes in a single envelope: a pentode, and a triode. The pentode section of the tube is connected to the aerial by way of an R. F. choke, labeled R.F.C. 1 in the circuit diagrams, Figs. 1 and 2. The output is then connected to the triode section through the use of R.F. coils, as illustrated. The pentode section of the 6F7 is not tuned. Now the 12A7 is a combination pentode amplifier and power rectifier of the half-wave type. Actually this tube was designed for use in "cigar box" receivers, and is suited admirably for our purpose here. The secondary of the A.F. transformer is connected to the control-grid and "C" bias resistor of the pentode amplifier, and the A.F. output is fed to the phones or loudspeaker.

The rectification of the power-line voltage is accomplished by the diode section of the 12A7 tube which is equipped with a separate cathode for this purpose. To facilitate wiring of this receiver, the pictorial diagram, Fig. 2, is shown with the base-pin connection of the two tubes used.

## IMPORTANT CONSIDERATIONS

It is very important that the fila-

ments of the tubes and the connections to the rectifier be made exactly as shown. The terminals of the power plug have been labeled "plus" and "minus," and these wires must be traced carefully when wiring the receiver. The 6F7 heater must be in that side of the line labeled "negative." (If this is not done there is a possibility of cathode-heater leakage developing rapidly and ruining the tubes.) The resistor should be placed where ventilation is best for this receiver dissipates considerable heat, which can be felt quite a distance away. Do not be alarmed if your hand should get comfortably warm when held 12 or even 18 ins. away from the resistor. (Incorporate R5 in the power cord, if you care to.)

The small condenser (C3A) which is shunted across C3, the main tuning unit, is a band-spread condenser. On 50 meters, for instance, a one-half rotation of this condenser corresponds to 1/20 of a rotation of the main tuning condenser, so that the spreading is very effective on this crowded channel.

The sockets for the tubes and the tuning coil are of the type which are raised above the board. This mode of construction is quite essential in breadboard receivers which utilize complicated wiring to a given socket.

Of course, that bugaboo, hum, may be apparent when used on A.C. unless care, *painstaking care*, is taken to keep all A.C. leads away from the tuning condenser, coil, and gridleak condenser.

(If the receiver is to be constructed from parts lying around the house, then the A.F. transformer, T1, may be replaced with resistance coupling. The plate resistor should have a value of 50,000 ohms; and the gridleak, 1 meg. In this case the coupling condenser must have a value of .006- to .1-mf.)

## LIST OF PARTS

- One Cornell-Dubilier condenser, .1 mf., C1;
- One Cornell-Dubilier condenser, 100 mmf., C2;
- One Hammarlund midket variable condenser, type MC-140-M, C3;
- One Hammarlund midket variable condenser, type MC-35-S, C3A;
- One Cornell-Dubilier condenser, 500 mmf., C4;
- One Cornell-Dubilier electrolytic condenser, 25 mf., 25 V., C5;
- Two Cornell-Dubilier electrolytics, 8 mf., 200 V., C6, C7;
- One Cornell-Dubilier condenser, .02-mf., C8;
- Two Hammarlund R.F. chokes, type CH-X, R.F.C. 1, R.F.C. 2;
- One Aerovox resistor, 300 ohms, R1;
- One Aerovox gridleak, 3 megs., R2;
- One Centralab tapered potentiometer, R3, 7,500 ohms, with line switch, Sw.;
- One Aerovox resistor, 1,000 ohms, R4;
- One Aerovox resistor, 300 ohms, 30-50 W., fully shielded, R5;
- One Standard Transformer Co. A.F. transformer, T1;

(Continued on page 431)

Fig. 8. The positions of the parts are evident from this rear-view photograph.

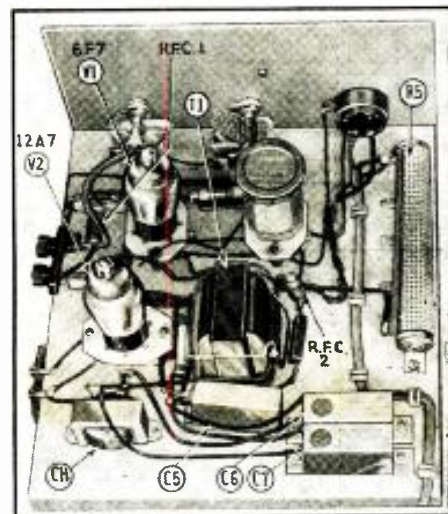
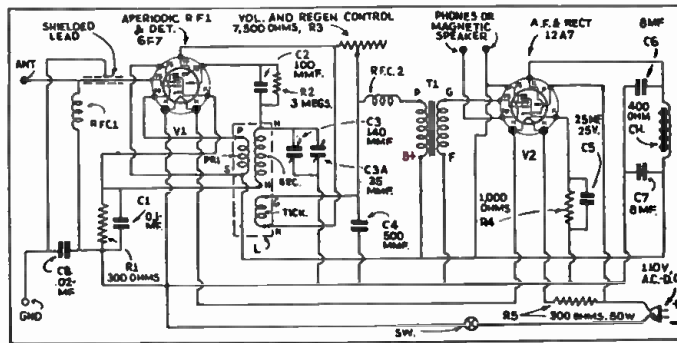
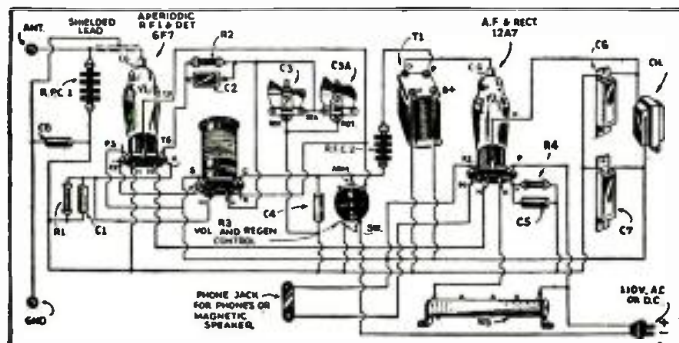

Fig. 1, below. The schematic circuit and Fig. 2, left, the picture circuit of the receiver. Condenser C3A is used for band spreading.





# USEFUL CIRCUIT IDEAS

Experimenters: Here is your Opportunity to win a prize for your pet circuit idea, if it is new, novel and useful.

AWARDS IN THE CONTEST	
FIRST PRIZE.....	\$10.00
SECOND PRIZE.....	5.00
THIRD PRIZE.....	5.00
Honorable Mention	

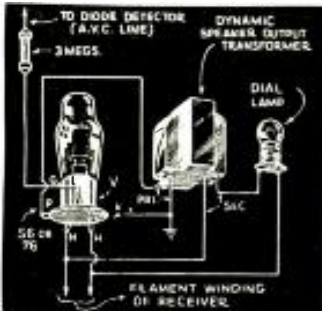

Fig. 1, above. Tuning indicator.

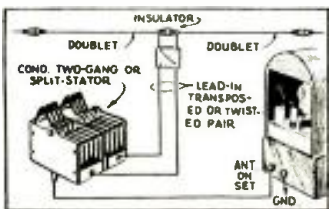

Fig. 2, Connecting a S.-W. doublet.

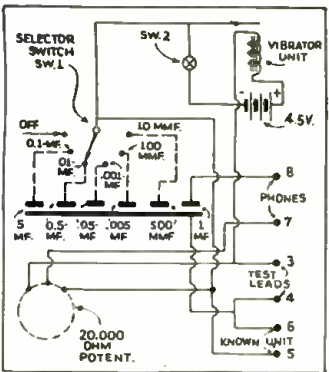

Fig. 3. Condenser tester.

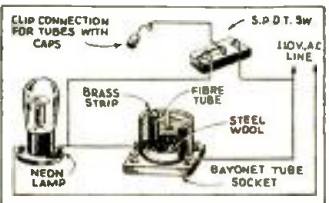

Fig. 4, above. Tube short checker.

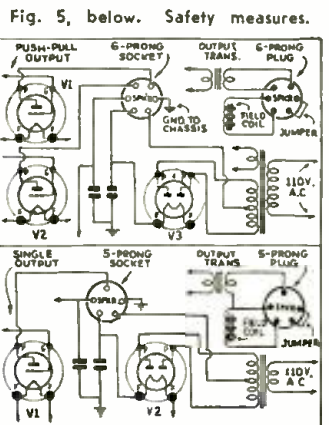

Fig. 5, below. Safety measures.

## FIRST PRIZE—\$10.00

**ALL-WAVE-SET TUNING INDICATOR.** Several of the new all-wave receivers use a simple yet effective tuning indicator in the form of a pilot light which burns brightly between stations and dims when a carrier is in tune.

The Service Man can make a few extra dollars installing such tuning indicators in existing sets of the type which use diode second detectors.

The circuit, Fig. 1, shows how it is done. A triode, such as the 56, 76 or 27 is connected to the diode detector (A.V.C. line) through a 3-meg. resistor. The secondary of an output transformer from a defunct dynamic speaker is connected in series with a small dial-light bulb. (2 or 5 volt, depending on filament winding voltage) to the regular filament winding of the set and the primary of this same transformer connects to the plate of the triode.

When a signal is tuned in, the voltage applied from the diode detector increases, thus increasing the "C" bias on the triode, and the plate current of this tube decreases, reducing the current drawn from the low-impedance winding of the transformer (and, hence, the current through the series lamp decreases).

EMIL KUZSMA

## SECOND PRIZE—\$5.00

**CONNECTING A SHORT-WAVE DOUBLET.** A lead-in of the transposed type or of the twisted type may be efficiently coupled to a set not provided with doublet antenna posts, as shown in Fig. 2, by utilizing a 2-gang or a split-stator condenser. The capacity of each section should be about 100 mmf. and is not at all critical. The condenser may be mounted out of sight, since once the adjustment is made it need not be changed, unless a "dead spot" is encountered, in which case a small change of capacity will cure the trouble.

WM. A. CLARK

## THIRD PRIZE—\$5.00

**CONDENSER TESTER.** Where power lines are not available, the bridge-type condenser tester described in the July, 1935 issue of *Radio-Craft* may be adapted for use with batteries by means of the circuit shown in Fig. 3. A high-quality buzzer should be used in order to insure a steady, pure tone. It will be seen that the buzzer takes the place of the winding of the power transformer, while the remainder of the circuit is very similar to the original. The operation is identical with that of the original.

ROMEO BUTTOLIO,  
S.S. Conte di Savoia.

## HONORABLE MENTION

**TUBE SHORT CHECKER.** This simple idea saves time and is very efficient. All the parts can be obtained from the usual junk pile, so the cost is very small. The old-

type socket has one terminal insulated so that it does not touch the steel wool that is placed in the socket, yet one prong at a time of the tube can make contact. The steel wool makes contact with all the remaining prongs, any shorts being shown by the neon bulb. The switch enables the element connected to the cap to be tested also. See Fig. 4.

DAVID STOBO

## HONORABLE MENTION

**REWIRING SPEAKER PLUGS.**

There is often trouble caused by removing the speaker plug when the set is in operation, or leaving the plug out and turning the set on. This is usually caused by the fact that the field of the speaker is used as a choke, and when the plug is left out, the filter condensers get the full voltage of the rectifier, without a load.

The speaker socket is replaced, one of 5- or 6-prong type being used, depending upon whether a single or push-pull output stage is employed. The idea is simply to connect the high-voltage winding center-tap to two of the open prongs of the socket. The equivalent prongs of the plug are shorted, so that when the plug is inserted the circuit is closed. When the plug is out, there is no high-voltage return, so no current can flow, thus protecting the condensers. See Fig. 5.

ANDREW KISYLIA

## HONORABLE MENTION

**REPLACING TYPE 27 TUBES.**

A single type 53 tube may be used to replace push-pull 27s in many cases with a consequent saving in space and current drain. All the original resistors, and other equipment are used. The original bias resistor of the 27s was found to give fine results. The results obtained from these converted stages are as good if not better than those of the original. Both are shown in Fig. 6.

JOS. G. TABACZYNSKI

## HONORABLE MENTION

**OUTPUT INDICATOR.** Regular

output meters are rather expensive and not always easy to obtain in a hurry. A standard A.C. voltmeter may be used by connecting it with a dynamic speaker output transformer, as in Fig. 7. The voltage will be stepped up enough so that a good reading can be had on a 0-150 V. scale instrument.

CHARLES FORSCH

## HONORABLE MENTION

**USING FILAMENT TRANSFORMER.** A small transformer used instead of a series resistor in A.C.-D.C. sets has many advantages. The tubes heat much more quickly and the total current drain is less than half. The new circuit appears in Fig. 8. The transformer may be very small, since the power needed is only around 15 W. for the filament circuit. Of course with this change, the set will only operate on A.C. Figure 8 shows how a complete

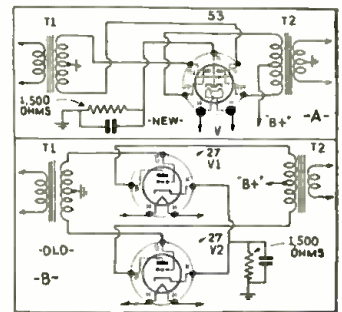

Fig. 6, above. Replacing 27 tubes.

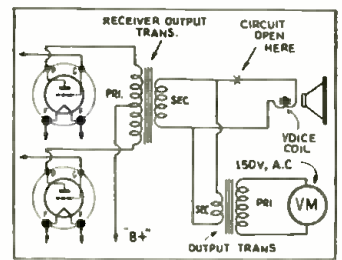

Fig. 7. Output indicator.

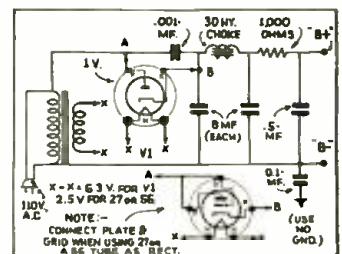

Fig. 8. A.C.-D.C. set change.

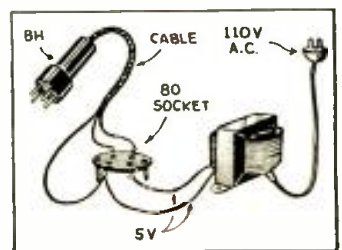

Fig. 9. Replacing the old BH tubes.

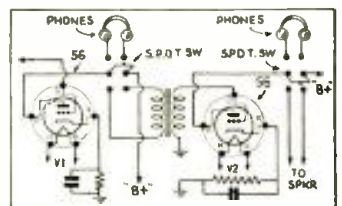

Fig. 10. Extra audio stage.

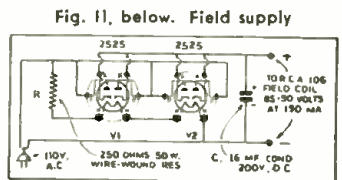

Fig. 11, below. Field supply

power supply may be made for a 4- or 5-tube set using this system.  
R. E. BUSH  
(Continued on page 432)

# HOW TO MAKE A FLOATING-GRID RELAY

Many interesting experiments can be made with this "capacity-operated" relay which parallels the grid-glow relay. Standard tubes and parts are employed in this unit.

E. L. DEETER

IN THIS article the author describes how use was made of a phenomenon in constructing a very sensitive and extremely versatile relay "system." (Refer also to the author's article, "How to Make a Sensitive Relay Unit," in the preceding issue of *Radio-Craft*. —Editor)

If the grid of an ordinary radio tube is entirely disconnected from circuits outside the tube and the base-pin cut off (in the case of 3-element tubes) to prevent leakage, the tube becomes sensitive to body-capacity effects, such as objects approaching in the proximity of

the tube, such as metal objects, etc.

A large number of tubes were put through tests to determine their characteristics with grid-elements thus "floating." The screen-grid tube is obviously best suited for this purpose mechanically, because of its well-insulated grid-cap which emerges from the apex of the tube and offers a suitable terminal for external connections. Electrically too the tube is to be preferred, the 38 type of tube showing the most desirable characteristics for the purpose, followed closely by other tubes such as the 39, (Continued on page 432)

Fig. 1. The fundamental circuit and characteristic.

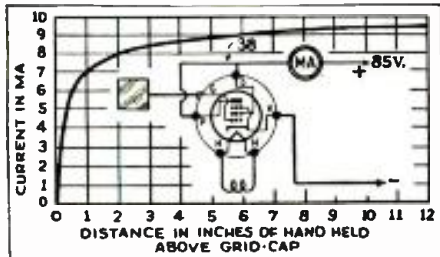

Fig. 3. A direct-coupled circuit which produces a "reverse" action for a capacity change.

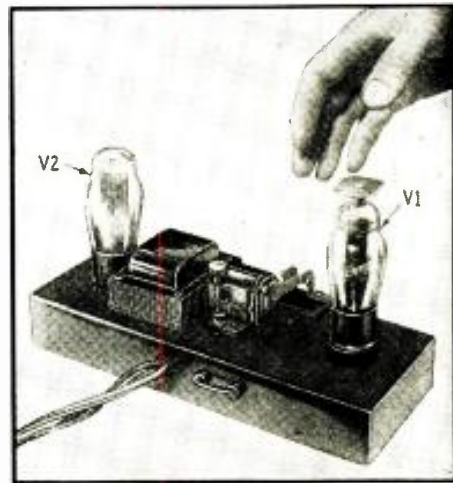
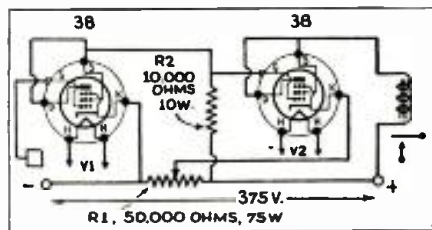
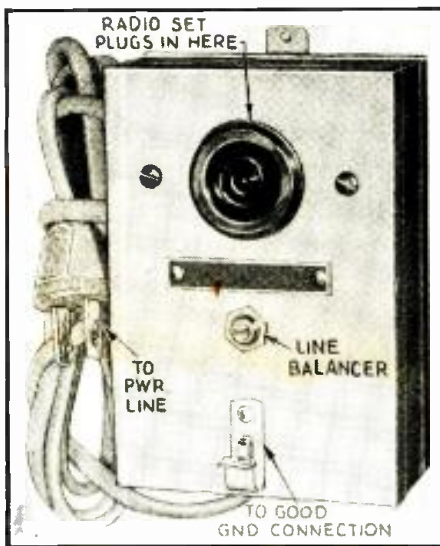
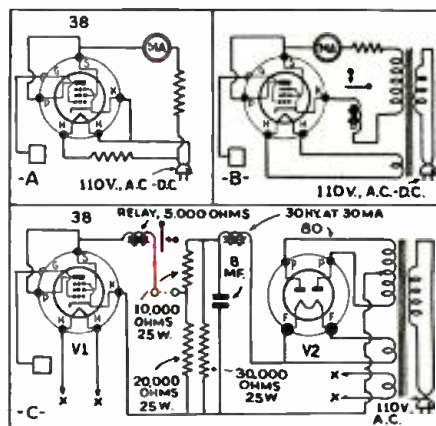

Fig. A, above. The appearance of the unit shown in Fig. 2 C, below.  
Fig. 2, below. Three experimental circuits.



## AN IMPROVED LINE-NOISE FILTER FOR ALL-WAVE SETS

Noisy operation in all-wave sets, on the short-wave bands is often due to line noises—which can be filtered.

ARTHUR H. LYNCH\*

to the chassis directly, or to the wooden box. In either case, a wire should be run from the spring binding post to the ground terminal of the set, and from there to a good ground, such as a water pipe. The ground wire should be as short as possible. The power cord of the receiver must be rolled into a 3 in. circle and tied with string, leaving just enough to run directly to the receptacle in the filter case. The plug attached to the filter runs to the nearest power socket.

With installation thus completed, turn the set on and tune it to a fairly weak station. Then turn the "Line Balancer"—on the commercial unit (R, in Fig. 1)—to the position where the interference is removed, or at least, very much weakened. In some cases of very bad line noise it may be necessary to reverse the position of the set-plug in the socket of the filter unit.

The efficiency of the installation may

be tested by turning any electric light on and off quickly, doing this with the filter both in and out of the circuit. When the correct balance has been found the click of the light will be found to have been entirely eliminated, or at least, greatly decreased. If this is not the case, the installation will probably be found to be incorrect. When correct balance has been made, the adjustment will be found correct for any station, or even for any band of an all-wave set.

A glance at (Continued on page 432)

Fig. 1. The circuit of the line filter. Potentiometer R has a resistance of 10 ohms.

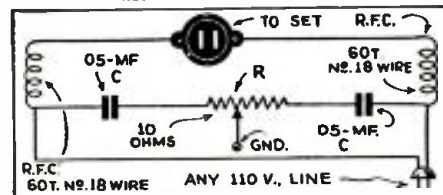

IT IS well known to radio engineers that a great deal of noise enters a radio set through the power line. It is useless to install a noise-reducing antenna in a noisy location, such as in a city, without using some means of filtering out the disturbances that travel along the power lines.

The installation of the device shown in Fig. A is very simple, and may be installed by anyone, even though they have no knowledge of radio. The filter unit may be placed anywhere in the set cabinet, it being practical to fasten it

\*Arthur H. Lynch, Inc.



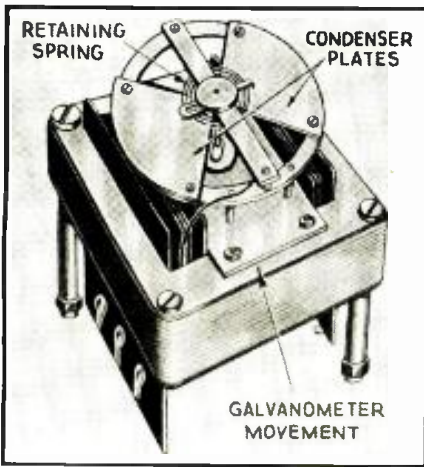

# THE NEW "SELF-TUNING" RADIO RECEIVER!

The difficulties of accurately tuning modern superhet. receivers are eliminated by this ingenious "tuning corrector."

This tuning corrector is fundamentally a plate-current meter with a small condenser mounted in place of the indicating needle. The action is a form of "bridge" which seeks a balanced condition.

denser of the amplifier. Now, as a station is tuned in, the plate current of the tube increases. This makes the meter movement operate, tending to increase the capacity of the small condenser. If the main tuning condenser is off-resonance with the station in such a way that an increase in capacity will bring it closer to the resonance point, the movement of the meter (and small condenser) will tend to increase the signal strength which will keep the meter turning until the signal strength no longer increases, at which time, the meter movement will cease to turn. If, on the other hand the condenser is off the exact tuning point on the other side of resonance, the increase in the movement of the meter will reduce the signal strength and cause the meter to return toward normal position (set by the spring shown in the heading illustration, which will (Continued on page 432)

**T**HE IMPORTANCE of having a receiver of the superheterodyne type, whether it is operating on the broadcast band or one of the many short-wave channels, tuned exactly to resonance with the station, has been recognized for some time. It is for this reason that manufacturers include visual tuning indicators of the meter, neon and cathode-ray types.

However, a new circuit has been developed in Europe to eliminate the need for such exact tuning—and still prevent the introduction of distortion which was encountered in sets, up to this time. The new device—which automatically tunes exactly to a station carrier—was one of the outstanding attractions at the recent Paris Radio Show.

A glance at Fig. 1A will explain the basis upon which the unit operates. A sensitive galvanometer movement is connected in the plate circuit of an R.F. tube and to this galvanometer is connected one plate of a small variable condenser, which is shunted across the regular tuning con-

Fig. 1. Two circuits illustrating the electrical action.

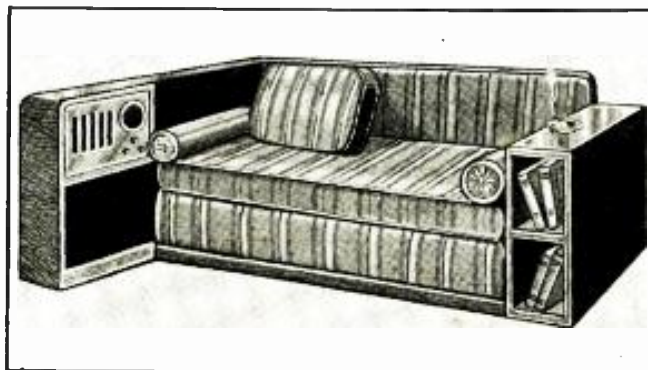
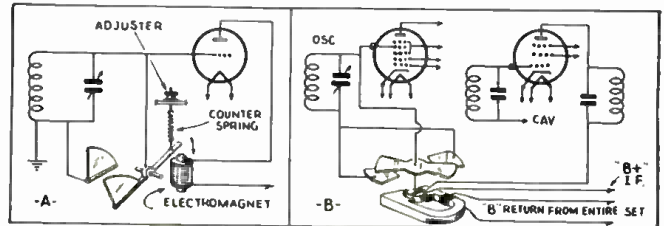

## NEW FRENCH "RADIO FURNITURE"

Radio sets built into modern suites of furniture offer new sales possibilities to manufacturers—and more business for Service Men.

A radio set as part of a living-room couch offers a fine spot for a comfortable evening of entertainment.

mounted in a bed-side stand which is made as a part of the bed itself.

If a radio receiver is desired in the dining room, a buffet radio will solve the problem; the French manufacturer supplies the set built into the buffet of the suite, as shown.

In the humble opinion of the Editor, these examples of "radio furniture" open a new era in radio design. The permanent in- (Continued on page 432)

**N**UMEROUS attempts have been made in the past to include radio receivers in pieces of furniture, where they are less obvious, or likely to match better with the furnishings of a room. Thus we have the kitchen radio which is finished in white and rests on the top of the electric refrigerator—the bathroom set which we described some time ago in *Radio-Craft*—the arm chair receiver which is mounted in an overstuffed chair, etc.

However, the attempts have been more or less adaptations of existing sets to serve a particular purpose.

A new group of receivers designed particularly for a certain type of furniture has been recently developed in France. Three of these radio novelties are shown on this page—the first (in the heading) is a radio couch into which the radio set is mounted in an extended arm at one end. Thus it is

an integral part of the piece of furniture, harmonizing with it—and designed for greatest convenience in tuning, etc.

Another type of installation is the radio bed. Here again, the radio set is a permanent part of the bed, being

Radio sets built into bedroom and dining-room suites are the latest European innovation in radio receiver manufacture, as these examples show.

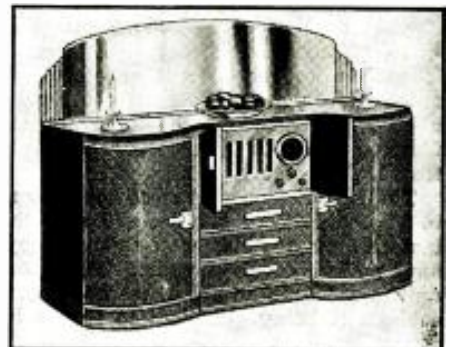
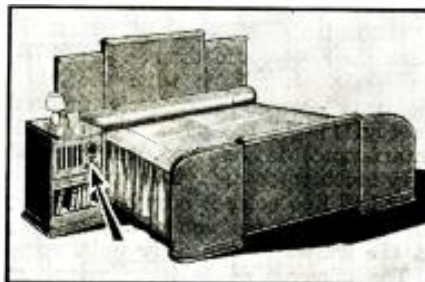

C. A. MORRISON

# THE LISTENING POST FOR ALL-WAVE DX-ERS

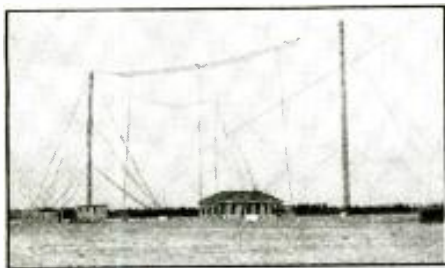

The Johannesburg broadcasting station of the South African Broadcasting Co.



The listening post of Sergeant H. J. Dent of the Royal Police Force, Bombay, India.

**T**HERE is an old saying that "the pen is mightier than the sword." This should be revised and brought up to date by stating that "the *microphone* is mightier than the sword." Short-wave broadcasting has become the most potent force in the molding of public opinion that the world has ever known. Emperors, Kings, and Presidents have forsaken the traditional dignity of seclusion and are openly rushing to the microphone to spread their governmental propaganda to the farthest corners of the earth in messages of oratorical eloquence. Il Duce, the iron man of Italy, has breathed his doctrines of conquest over the air not once but many times, both leading up to, and since the beginning of the African struggle. Soft spoken Haile Selassie, the King of Kings, has also had his chance to appeal to the peoples of the world as he faced the microphone in Addis Ababa. If it wasn't for the grim reality of "death from the skies," "whippet tanks rushing along like the wind," and "gruesome guerilla encounters," one might almost be persuaded to conjure a vision of a court-room scene with Il Duce, and Haile Selassie in the roles of prosecutor and defendant, the League of Nations as the judge, and the peoples of the earth composing the listening audience as the jury. For, the force of united world public opinion will be a vital factor in the present armed conflict.

Regular early evening activities are almost forgotten, as radio listeners everywhere turn to the world news bulletins with breathless interest to learn at first hand the latest developments in the Italo-Ethiopian struggle. The newspaper remains unopened as living and actual headlines stream from the loudspeaker. Within the compass of one short hour, four or five important news reviews may be heard. For first-hand information direct from Rome, turn to 2RO (9.64) on Monday, Wednesday, and Fridays at 7:15 pm E.S.T.; Pontoise, France, is on the air daily at 7:20 pm E.S.T., with the French version of the day's news, in English. This can be followed up by your choice of Boake Carter over W2XE (11.83), or the Daventry Stations (GSB 9.51-GSC 9.58) at 7:45 pm E.S.T. To conclude this international news festival, you can tune in Zeesen, Germany, (DJC-6.02, DJN 9.54) for the German angle to the day's events. It is very enlightening to hear the same news items viewed through the political eyeglasses of the various nations included in the above review.

And now for news direct from the center of activities in Addis Ababa, Ethiopia. Unfortunately only one weak station must furnish key information from the center of actual activities. Try for ETA, the little 2 kw. short-wave station which transmits irregularly on 7.62, and 18.27 mcs. ETA is a real DX catch, and probably will not be heard by many of our readers, but on the occasion of Emperor Haile Selassie's recent speech, this station was not only picked up direct by the receiving station of RCA Communications at Riverhead, Long Island, but was also reported by several DX-ers along the Atlantic coast. So, if this tiny but immensely important radio station has not been blown into atoms by the time this article appears in print, keep your ears tuned to these channels for real live uncensored news from the heart of things.

## THE BROADCAST BAND, DECEMBER AND JANUARY

This period marks the zenith of broadcast band DX reception in North America, for with the long hours of darkness, the air is literally filled with foreign broadcast transmissions for the initiated who know when, and how to tune them in. On the eastern seaboard, European stations will be coming in with their greatest signal strength, South Americans will be pushing through the local stations in the early evening hours with ever increasing activity. DX-ers should watch for Japanese stations in the hours before daybreak, and may even be lucky enough to tune in a Chinese station. Broadcasts emanating in Australia, or New Zealand will not be as strong as they were earlier in the Fall, but should be received well, at times, in the early morning hours.

Broadcast-band DX listeners in the Central States never receive foreign DX with any great volume, because of their long distance from any large body of water and the screening effect of the large mountain ranges, but they do receive a larger variety of signals due to their more central location. European DX is quite rare in the Central States, but South Americans are often quite well received, and although not common, it is not really rare to tune in Japanese and Chinese stations. In the Fall and again in the Spring, Australian and New Zealand stations are well received in the Central States.

West Coast listeners will be receiving so many Japanese stations on good nights that they almost constitute a nuisance. The louder Chinese stations also will be heard, and Hawaii comes in with local regularity. It is not uncommon to receive transmissions from Siam, or India on exceptionally favorable nights. These Asiatic signals are heard from about 1:00 am P.S.T. to almost daylight. Australians, and New Zealand (Continued on page 434)

The radio telephone station at Buenos Aires, Argentine, used for commercial telephone communication purposes.







# SERVICING THEATRE SOUND SYSTEMS

PART II

In this part, the author covers the subject of amplifiers, both the ordinary and the high-fidelity theatre types.

A. V. DITTY

**T**HE DIFFICULTIES encountered in the amplifiers used in theatre sound equipment may be divided into several general classifications, each of which is covered below.

If the Service Man will remember that the amplifiers used in theatre equipment are the same as amplifiers used for radio and P.A. work (except for mechanical appearance) very little trouble will be encountered in repairing them.

## USUAL TUBE TROUBLES

Some of the early head amplifier equipment used two 01As or 12As in line, transformer-coupled as per Fig. 7A, and required an external D.C. supply for the filaments and sometimes the plate circuits. The included PE. cell circuits were also supplied with anode potential by external batteries. Dry "B" batteries used with such equipment will cause frying noise in the sound when they get weak or old. Other troubles are frying noises caused by leaking bypass condensers, and cut-off in the sound due to intermittently shorting bypass condensers or "intermittent" transformer windings. Condensers shorting-through kill the plate voltage and consequently the sound. High-leakage or shorted condensers will also cause a constant drain on the batteries, thus making them short-lived.

Paralyzed and weak tubes will cause low volume and lack of distinctness in the sound. Defective tubes, particularly the indirect-heater type have also been the cause of frying noise and cutting off, as well as microphonic howls and disturbances. Tubes should be tested regularly for emission. Tapping the tubes gently with the fingers will show up noisy or microphonic units. The best test however is to substitute one or more new tubes for the suspected one and to compare results under actual operating conditions. Output leads should be kept away from input leads and input tubes as much as possible in order to prevent humming and howling in the sound.

Basic PE. cell circuits are shown in Fig. 7B. The load resistor and anode voltage vary with the specified requirements of the cell. A load resistor of 1 or 2 megs. is generally used and gives a good response characteristic. A potential of 60 to 90 V. maximum is impressed upon the cell through a load resistor. The maximum current should never be more than 20 microamperes. The PE. cell characteristic is increased with a decrease in size of the load resistor, while an increase in cell output is obtained by increasing the load resistor. A value of 1 or 2 megs. strikes a happy medium between high quality and high output.

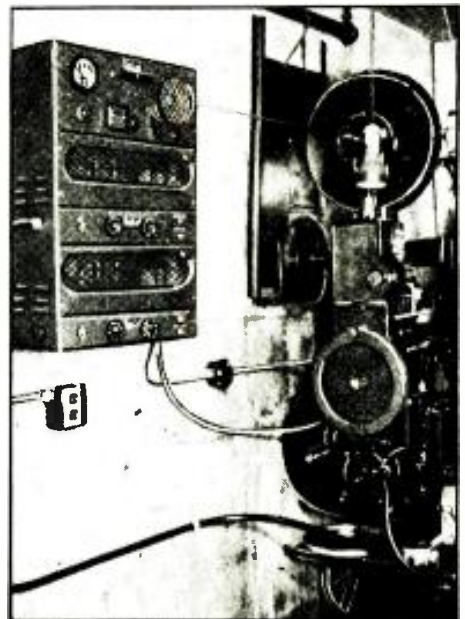

Fig. C. A high-fidelity installation using a 15 W. dual-channel amplifier (at left) and projector.

## COUPLING UNITS

Coupling in some equipment is made through an auto transformer, (Fig. 7C), while in others, through a small condenser. A PE. cell will become weak or paralyzed and noisy, just the same as will radio- and amplifier-type tubes. While comparative readings may be obtained with a microammeter the best test is to substitute a new cell.

Type 27, 56, 57 and 58 tubes and others of similar characteristics are being used in most brands of later equipment; 27s and 56s in circuits similar to Fig. 7A, while 57s and 58s are generally used according to Fig. 7D. The transformer output of circuits as per Fig. 7A are coupled through fader arrangements (Fig. 8) to the main A.F. amplifiers by input transformers having the same primary impedance as that of the secondary of the head amplifier output transformers. Impedance matching is (Continued on page 437)

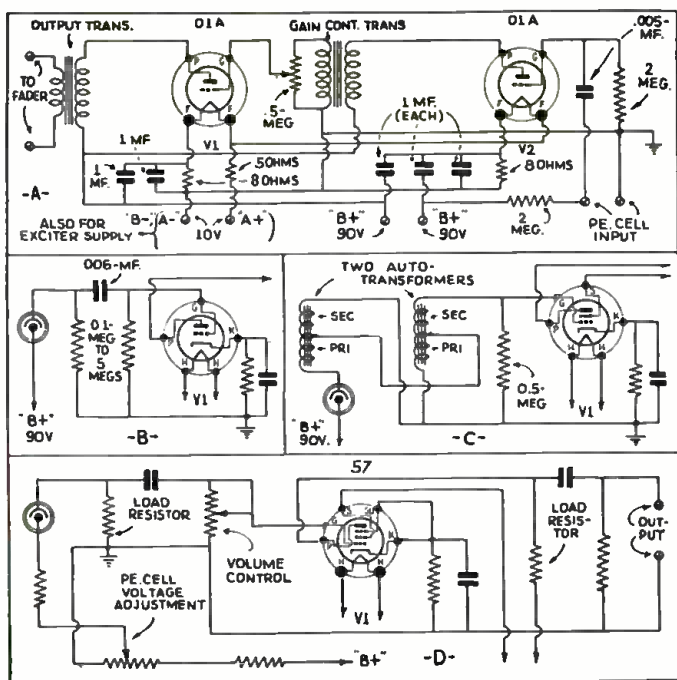
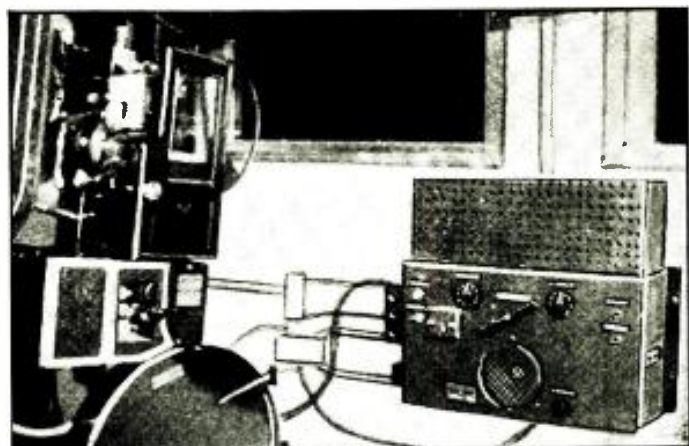
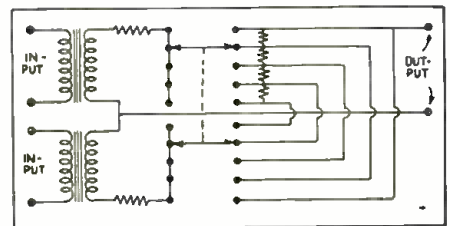
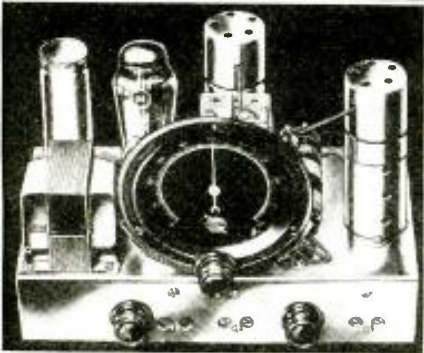

Fig. 7, left. Amplifier circuits used in different types of equipment. Fig. 8, right. A typical, constant output impedance fader circuit. Fig. D, below. A modern 12 W. amplifier containing monitor speaker, PE. cell and exciter lamp supplies, gain control, bass compensation, etc.







Above, 2 views of the preselector.

# AN EASILY-BUILT SHORT-WAVE PRESELECTOR

This preselector is easily built from the coil kit furnished, and makes efficient addition to any set.

PAUL O'CONNOR

**T**HE ADVANTAGES of pre-selection and pre-amplification employed ahead of any short-wave superheterodyne or tuned R.F. receiver are well known to most short-wave fans.

Here is a simple, inexpensive and really practical preselector that will give more distance and sensitivity with lower noise and absolutely no images. The coils cover the full range from 12 to 200 meters.

Actual measurements as well as listening tests made by well-known amateurs and short-wave fans show a pronounced increase in signal strength when the preselector unit is added to

any receiver. *Efficient coil design makes R.F. amplification practical at frequencies as high as 25,000 kc. (25 mc.)*

## PRESELECTOR REQUIREMENTS

A summary of the requirements of a good preselector unit discloses that its design should include (1) simplicity of operation, (2) two stages of tuned R.F. amplification, (3) high-gain coils, (4) absolute image elimination, (5) operation from either single wire or doublet antenna, (6) fool-proof band-change switch, and (7) efficient output system and self-contained power supply.

The principle source of tube noises in a receiver are those generated by the electron stream in the first-detector, commonly known as "shot effect," and are apparent when receiving weak signals. When pre-amplification is used to operate the mixer tube at a higher

(Continued on page 433)

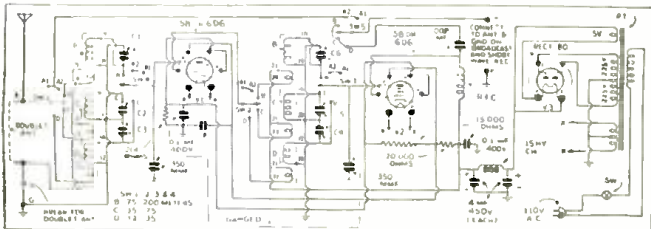

The band switch of this unit has a position to connect the antenna directly to the set, cutting out the preselector entirely, if desired.

# AN "ACORN"-TYPE ULTRA-SHORT-WAVE SUPERHETERODYNE ("AUTODYNE"-TYPE)

Here is an advanced ultra-short-wave set which is not a super-regenerator, and so lacks the loud hiss.

HUBERT SHORTT\*

**F**ULL ADVANTAGE is taken of the excellent characteristics of the type 954 "acorn" tube in a new 2½- and 5-meter superheterodyne receiver known as the "Lafayette"; it was designed by Frank Lester, W2AMJ, well-known amateur and engineer.

Examination of the accompanying diagram reveals that this receiver employs a type 954 "acorn" pentode in a tuned R.F. stage, followed by another 954 as a tuned autodyne detector and semi-automatic volume control tube and a 42 output tube complete the circuit. The action of the autodyne detector is controlled by a 50,000 ohm potentiometer in the screen-grid circuit, while audio volume is regulated by a ½-meg. potentiometer between the 41 and 42 tubes.

Due to the internal construction and design of the 954s very little noise that is due to thermal agitation is heard in this set. Although the overall gain is much higher than in conventional super-regenerative receivers, the background noise is at a very much lower level. (There is still some question as to whether the acorn is more "noiseless" than other types.—Editor)

Although 6 tubes are used, the entire receiver unit is built onto a copper-plated chassis measuring only 11 x 7½ x 9 ins. No power supply is included, as the same receiver chassis is designed for operation either on a 6-V. storage battery and dry "B" (Continued on page 441)

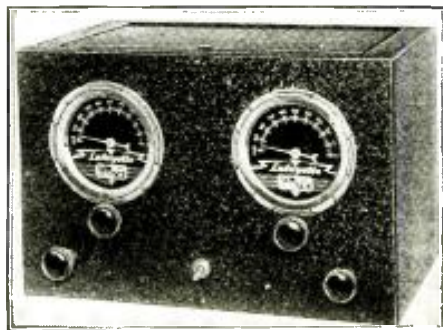

Outside appearance of the high-frequency super.

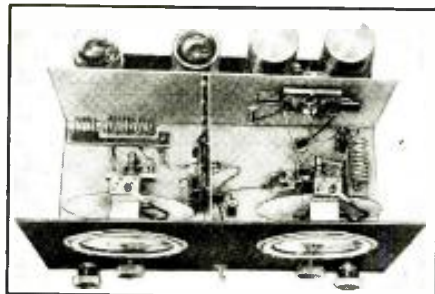

Above, placement of parts. Note plug-in coils.

Below, the circuit diagram. Separate tuning controls are used. Includes A.F. and R.F. volume controls.

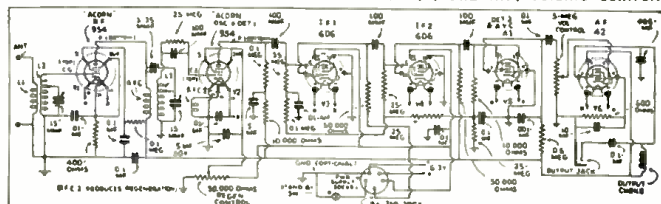

\*Wholesale Radio Service Co.

# RADIO-CRAFT'S INFORMATION BUREAU

## P.A. QUESTIONS & ANSWERS

Conducted by  
CHARLES R. SHAW

Here is a new department for the Radio Dealer, Service Man and Sound Technician who require general information and help in P.A. work. This department will furnish valuable aid for the asking. Address all questions to *Radio-Craft's* Public Address Forum. Only those questions of general interest will be published and we reserve the right to publish any of these inquiries and answers.

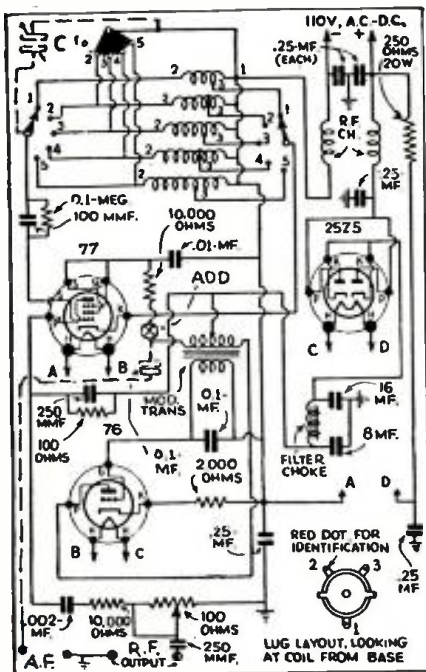

Fig. Q.351, above. Oscillator changes.

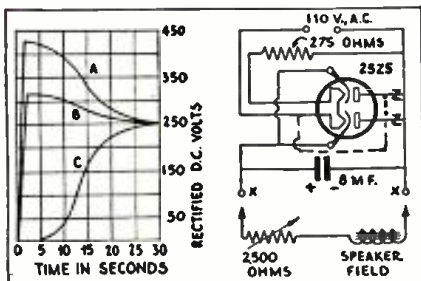

Fig. Q.352. Speaker supply correction.

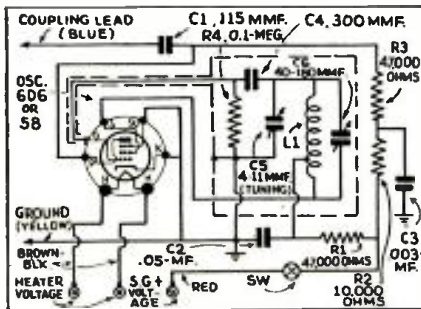

Fig. Q.353B, above. Circuit of beat oscillator unit, photograph of which is Fig. Q.353A, below, courtesy RCA.



### AUDIO OSCILLATOR SIGNAL

(351) Mr. Curtis Falls, Kings Mt., N. C.  
(Q.) I have built the Service Man's all-wave oscillator, described in the Jan., 1935, issue of *Radio-Craft*, but would like to have it arranged so that I can use the audio section alone for testing amplifiers and the like. What changes are necessary to do this?

(A.) We have reprinted the original circuit herewith, with the changes made in dotted lines. The only additions needed are a .1-mf. condenser and a single-pole switch. The latter cuts the screen voltage of the R.F. oscillator, allowing all the audio signal to be fed to the A.F. output posts, which have been added. Notice that a tuning condenser, c, has been added in the top left corner. This was omitted, by mistake, in the original diagram.

### CONVERTING A.C. SPEAKERS

(352) Russell Smith, Lowell, Mich.  
(Q.) I would like to convert some A.C. 106 RCA speakers to use the 25Z5 tube, but can get no result from the diagram on page 227 of the Oct., 1933 issue of *Radio-Craft*. Can you give me any help on this?

(A.) The correct circuit of this appears at Fig. Q.352. The original circuit is reproduced in solid lines. The dotted line from filament to plates should be added. Also the plates should be removed from the A.C. line to which they are connected, by breaking the leads at "Z, Z". This will give the proper output voltage.

### ADDING BEAT OSCILLATOR

(353) Mr. T. D. Pentz, Elizabeth, N. J.  
(Q.) I wish to add a beat oscillator to my all-wave receiver. Can this be done without changing the set very much? Will it be possible to hear code signals with this arrangement?

(A.) A simple way you can add a beat oscillator without changing the set itself, is to build a separate unit and attach it to the set with clips under tube prongs. Figure Q.353A shows a ready-made unit of this type made by RCA. It is powered by the set to which it is attached. The circuit appears at Fig. Q.353B. It is not possible to receive C.W. signals on the average set, unless an oscillator such as this is used.

### "5 METER TRANSCIVER"—A CORRECTION

(354) Mr. Joseph LeBore, Yuma, Arizona.  
(Q.) I have built the transceiver described on page 140 of the Sept. issue, but the signals are very weak on it. What can I do to strengthen them?

(A.) The condenser C5 shown in Fig. 1 was incorrectly printed and should be made 1 mf., instead of .001-mf. as shown. This will give you a much stronger audio signal in the phones, with better quality.

### DIFFERENCE BETWEEN MAGNETS

(355) Raoul Dutemple, Montreal, Canada.  
(Q.) Could you tell me the difference between a solenoid type of winding, and a universal type?

(A.) The solenoid type winding is generally considered, in radio work, to be one which has only a single layer of wire. Some solenoids however, have many layers, but the layers run the whole length of the core, as in the case of relay windings. A universal type winding has many layers, one on top of the other, but the individual turns run from side to side of the winding. Honeycomb coils and some R.F. chokes are wound this way. Solenoid coils usually have a greater length than diameter, while universal coils are just the opposite.

(Continued on page 442)

### LOW OUTPUT

(26) Mr. Clarence R. Kruger, Saginaw, Michigan.

(Q.) I recently finished building a 15 W. (2-2A3) amplifier using push-pull all the way through—2-57, 2-56, 2-2A3, with fixed bias using 2-5Z3, but I can't get over 6 or 8 W. of undistorted output. Can you tell me how I can eliminate the motor-boating and get more volume with better quality?

(A.) The distortion you complain of may be caused by any one of the following factors: (1) overloading the first screen-grid stage, (2) improper input push-pull transformer, (3) improper output transformer, (4) incorrect operating voltages. Motor-boating can be completely eliminated by additional plate and grid resistor decoupling resistors and bypass condensers as per Fig. Q.26.

### HIGH FIDELITY

(27) Mr. John Sechuertz, Louisville, Kentucky.

(Q.) Just what is meant by High-Fidelity? Are there any legal or recognized standards for high-fidelity amplifiers with respect to frequency range, noise level, audio distortion, hum level, etc.?

(A.) A set of tentative standards have been set up by the Engineering Department of the Federal Communications Commission for high-fidelity transmitting stations. These standards may be applied to audio amplifiers, inserting slight revisions—i.e., the total audio distortion shall not exceed 10 per cent at maximum output or 5 per cent at rated output throughout the range of audio frequencies from 50 to 7,500 cycles. The audio frequency characteristics of the amplifying system measured from microphone terminals to speaker voice-coil terminals

(Continued on page 442)

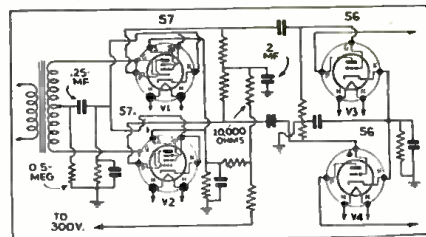
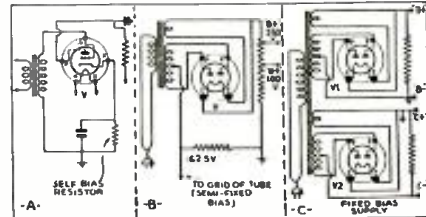
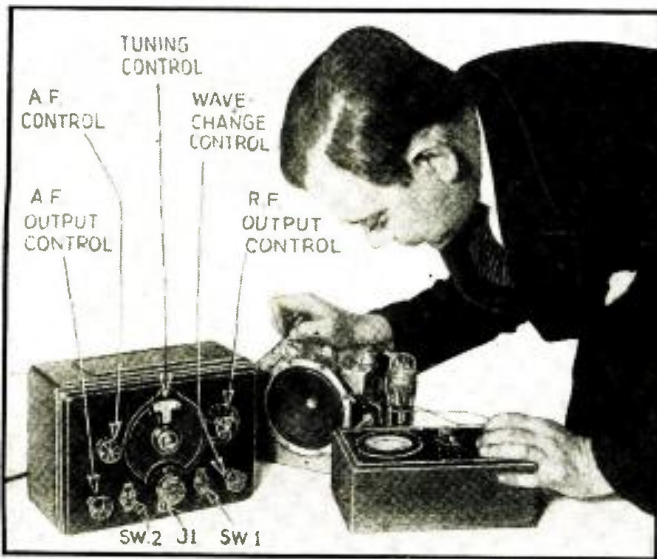

Fig. Q.26, above. Increasing audio output.

Fig. Q.28, below. Various bias supply circuits.







# HOW TO MAKE THE RADIO-CRAFT METAL-TUBE ALL-WAVE OSCILLATOR

An ultra-modern "signal generator" unit which covers all requirements for service and experimental work; it is an extremely flexible unit, which works on any A.C. or D.C. line.

C. W. PALMER

**T**HE *Radio-Craft* ultra-modern 3-tube all-wave service oscillator, or as we might find the name in a German magazine — Ultramoderner-dreirohrenversuchsschwingungserzeuger (!)—covers a very definite place in modern radio servicing.

There are certain faculties which a signal generator for service work or laboratory experimental work must have in order to properly fit into the varying conditions encountered today. Briefly, these are—

- (1) The signal generator must cover all frequencies used in modern radio communication, including those frequencies used for I.F. amplifiers.
- (2) The output must be variable over wide limits and be substantially flat over any given frequency band.
- (3) It must be modulated at audio frequencies and the frequency of modulation must be adjustable over a range of at least 100 to 7,500 cycles.
- (4) Provision must be made for "wobbling" the R.F. output frequency over any desired range of frequencies, for adjusting high-fidelity equipment and band filters.
- (5) Provision must be made for the injection of an external modulator for adjustment of high-fidelity A.F. amplifiers, or other set-ups requiring special modulator conditions.
- (6) The "carrier" frequency of the

R.F. oscillator must not "drift" on any portion of the band, or be affected by changes in applied potential or frequency of A.F. modulation.

(7) The oscillator must be accurately calibrated on all frequencies and maintain its calibration over reasonably long periods.

As an answer to these requirements as well as others not mentioned, the *Radio-Craft* ultra-modern signal generator was designed. It covers all frequencies between 90 kc. and 25,000 kc. (25 mcs.) in 7 bands; the output is variable from a portion of a microvolt to approximately 0.1-V. (r.m.s.), in two steps; a high- $\mu$  triode 6F5 tube is used as a modulator, the frequency of which is adjusted by a "tapped condenser" having capacities varying between 50 mmf. and .01-mf. Seven audio frequencies are thus produced between (approx.) 100 and 7,500 cycles. A jack is incorporated in the circuit so that a "wobbler" can be plugged in. (In a forthcoming issue, several novel and useful wobblers for this signal generator will be described.)

## THE CIRCUIT

An examination of the circuit shows how the various points mentioned above are covered. A 6L7 injection-grid frequency-converter tube is used as the R.F. oscillator. The peculiar construc-

tion of this tube makes it particularly suitable for the purpose, due to the double control-grid arrangement. The top-cap grid is used as the R.F. control-grid, while the second control-grid acts as an injection grid for the A.F. modulation frequencies. (Further details about this interesting tube will be found in the October issue of *Radio-Craft* on page 204.—*Editor*)

A conventional regenerative circuit is used for the R.F. oscillator, the 7 frequency bands being made possible by the use of an RCA all-wave oscillator coil. Since this coil assembly is calibrated for use with the condenser which is used, the problem of calibration—which has stumped so many radio men when making oscillators and frequency meters—is eliminated. A trial or two against known standards (such

(Continued on page 443)



The rear of the chassis with tubes in place.

The under side of the chassis showing assembly.

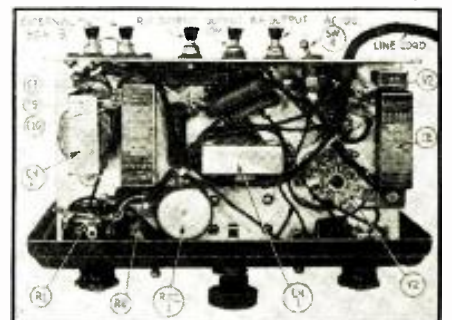





# THE LATEST RADIO EQUIPMENT

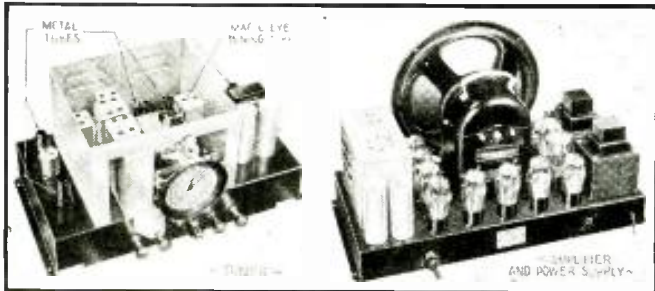

A 24-tube high-fidelity all-wave superheterodyne which utilizes 2 chassis. (873)

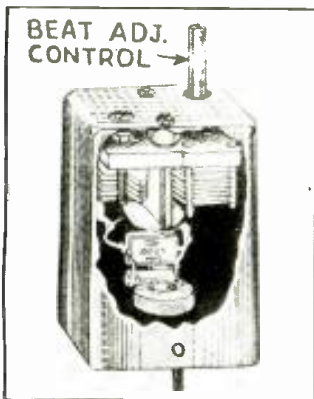

Tuning by whistle. (874)

## 24-TUBE ALL-WAVE SUPERHET. (873)

(Wholesale Radio Service Co., Inc.)

**T**WO CHASSIS are used for this large, high-fidelity set, one for the tuner containing 13 metal tubes, and one for power supply and audio amplifier, with 11 glass tubes. A cathode-ray tuning tube is used. The output stage operates in class AB and delivers about 50 W. The range is 8 to 2,050 meters, covered in 5 bands. Features, among others, include: variable band width I.P., automatic tone control, operation on any line voltage up to 250, dual speakers (one 12 in. auditorium-type, and one 10 in. high-frequency type).

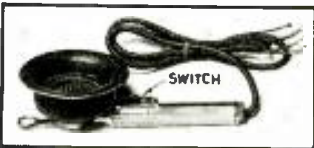

Improved hand mike. (875)

## BEAT-NOTE-TYPE "STATION FINDER" (874)

(Tobe Deutschmann Corp.)

**S**TATION finding by the "whistle method", or C.W. reception, is made possible by the use of this instrument. It includes, in a shield can, all the necessary components for the beat oscillator circuit, except the tube. A coarse (440 to 470 kc.) and fine adjustment are provided, the latter being made by means of a convenient knob. Air tuning condensers are used.

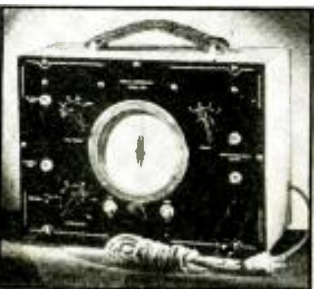

Above, new oscillator. (876)

## POLICE-TYPE HAND "MIKE" (875)

(Universal Microphone Co.)

**A** HAND microphone designed for use in police-radio work, but

Below, new 5Z4. (877)

Newest capacity meter. (878)

Air-driven generator. (879)

New 5-meter antennas. (880)

A 6-meter job. (886)

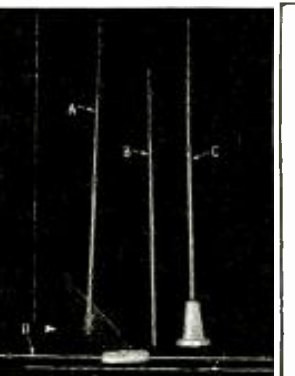

adaptable to any use requiring a small microphone suited to "close talking." is illustrated. It contains a sliding switch which may be used to operate a circuit other than that of the microphone circuit itself—for instance, a control relay. Unit is furnished with sponge rubber mouthpiece and 3-conductor cable.

## ELECTRON-COUPLED ALL-WAVE OSCILLATOR (876)

(Supreme Instruments Corp.)

**A**N ELECTRON-COUPLED circuit is used in this new oscillator. Three tubes are used, one of these being operated as audio modulator. External modulation with microphone or phono pickup may be used. Range: 90 kc. to 30 mc.; ranges are directly printed on the dial. Has ladder-type attenuator with multiplier switch and variable control calibrated in relation to output in microvolts.

## NEW, SMALLER 5Z4 METAL RECTIFIER (877)

(Hygrade Sylvania Corp.)

**A** NEW 5Z4 tube which is exactly similar to the 6F6 metal tube in outward appearance and size has been developed. It is said to be superior to the old "bird cage" type in efficiency and other characteristics. It can be used as a direct replacement for the old 5Z4 and 5Y3 type tubes. The electrical ratings are the same as for the older types.

## 100 MMF. TO 10 MF. CAPACITY METER (878)

(Weston Electrical Inst. Co.)

**F**OUR RANGES are available on this new capacity meter. Full-scale readings are 10, 1, 0.1, and 0.01-mf., and as low as 100 mmf. can be read. Operates direct from 115 V., 60 cycle A.C. line; (a transformer insulates the device from the line). Provided with voltage adjuster; supplied with a pair of long test leads. Size is 5½ x 3¾ x 2½ ins. deep.

(Continued on page 440)



Full-vision oscillator. (881)

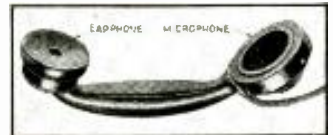

A 5-meter hand set. (882)

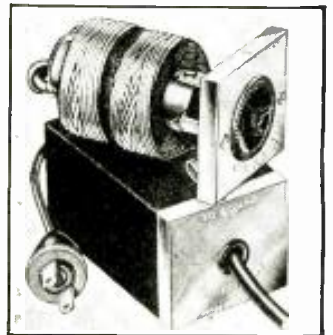

All-wave noise filter. (883)



Dynamic tube tester. (884)



Above, 5-meter receiver. (885)

Name and address of any manufacturer will be sent on receipt of a self-addressed, stamped envelope. Kindly give (number) in above description of device.

# A 1936 9-TUBE S.-W. COMMUNICATION RECEIVER

This 545 to 16,000 kc. receiver may be used by the Short-Wave Listener, the Amateur and the Professional, alike.

M. WILLNER

**T**HIS NEW receiver, while designed primarily for "communication work," should appeal to the discriminating short-wave listener, since its features provide a combination of quiet operation and extreme sensitivity which is quite unusual. For this reason it will doubtless be widely used by the DX fan. (The price is very low for a set of this type, a fact which will further increase its popularity.)

The 1936 Super Skyrider is a 5-band receiver, tuning the following frequencies:

- Band No. 1—1,530 kc. to 545 kc.
- Band No. 2—4,200 kc. to 1,495 kc.
- Band No. 3—11,500 kc. to 3,950 kc.
- Band No. 4—22,750 kc. to 8,000 kc.
- Band No. 5—48,000 kc. to 16,000 kc.

It includes 5 sets of R.F. and antenna coils, and 4 oscillator coils. The harmonic of the 4th oscillator coil is used to cover the 5th band.

A special antenna input circuit is used which provides very even transfer

of energy from the antenna circuit to the R.F. tube on all bands. A doublet may be used or the usual antenna-ground combination will be found very satisfactory.

When the crystal of the filter unit is switched out (Continued on page 439)

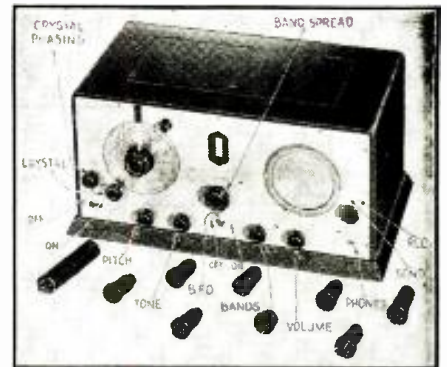

Above, the micrometer scale of the main tuning dial (left) permits accurate setting and reading. A metal pointer moves vertically over the dial to indicate the particular band in use.

Below, diagram; dotted leads refer to speaker.

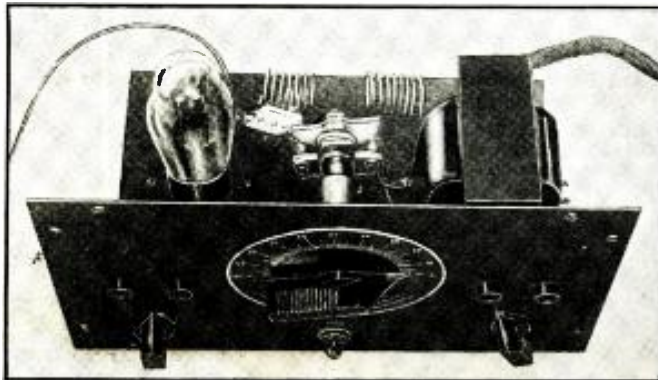
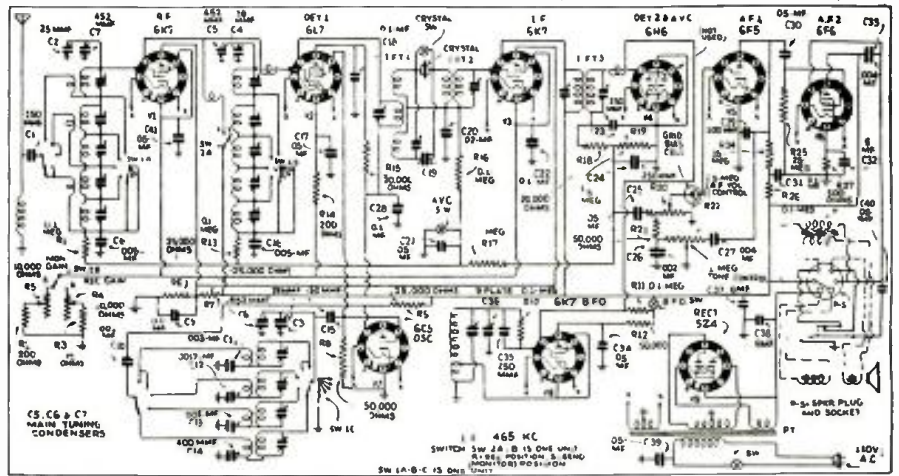

The plug-in coils which enable quick band shifting are clearly shown.

**P**RACTICALLY all transceivers for the 5- and 10-meter bands operate as regenerative oscillators for transmission, and as super-regenerative circuits for reception. For transmission the emitted wave should be as sharp as possible. For reception, it is important to have high sensitivity (the chief advantage of super-regeneration), and also not too much selectivity, so one may "hold" a station that is sending a wobbly wave.

The 1-tube transceiver here illustrated and described

\*Radio Constructors Laboratories

The grids of the two sections of the tube are really direct coupled.

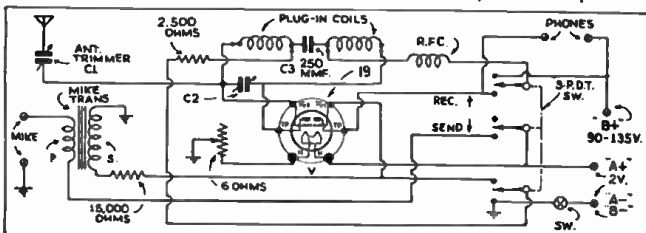

# A 1-TUBE BATTERY-TYPE 5- AND 10-METER TRANSCEIVER

Simplicity and efficiency are stressed in the design of this versatile "5 and 10" set.

MAXWELL M. HAUBEN\*

follows this practice, achieving results with minimum parts and wiring complexity. A T.P.D.T. switch is used to change from "send" to "receive." A type 19 is the only tube used, and as this unit consists of two high-mu triodes, both are in use either in "send" or "receive" positions of the switch. For transmitting, a carbon microphone is connected across the matched primary of a transformer that has high secondary impedance for grid-circuit loading, and there results series grid modulation of the oscillator through the drop in the secondary. A resistor limits the per cent of modulation.

For reception, the capacity between the plate of the super-regenerating triode (left) and the grid of the other triode (right) is sufficient to transfer the R.F. energy, developed as the voltage drop across 15,000 ohms and S., so that detection takes place in the second triode; the A.F. actuates the phones in the plate circuit.

Such a circuit is particularly attractive to the beginner, or for portable use by anyone, and the correct ranges will be covered if the capacity of the tuning condenser and the inductance of the tuning coils are right. A 3-plate unit, C2, of 25 mmf., is used for tuning. There is one coil assembly for the 5-meter band, consisting of 2 coils of 4 T. each, wound with No. 14 tinned wire, (Continued on page 439)



RCA VICTOR MODEL T5-2 5-TUBE, 2-BAND A.C. SUPERHETERODYNE RECEIVER

(Ranges, 540 to 1,720 kc.; 1,600 to 3,500 kc.; power output, 3.5 W.; 7-tube performance; antenna wave trap; A.V.C.; tone control)

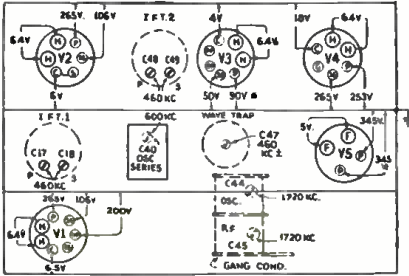

Above, socket voltages and trimmer locations.

When adjusting the I.F. trimmers, short the antenna and ground leads and turn vol-

ume on full. Adjust trimmers C49, C48, C18, and C17 in order. The wave trap is adjusted by tuning dial to point where intermediate-wave interference is greatest. Adjust wave-trap to point of best suppression. Connect oscillator to antenna and ground terminals. Check position of dial pointer on set, which should be at 540 when plates are at full mesh. Set oscillator at 1,720 and, with set on broadcast band, adjust trimmers C44, and C45 for best output. Retune oscillator to 600 kc. Turn receiver selector to point where oscillator signal comes in best (not necessarily at 600 on dial) and adjust trimmer C40, then check C44. The adjustments must be made irrespective of dial indications. No adjustments are required for the medium wave band. The above procedure should be followed in order to obtain maximum output from the set.

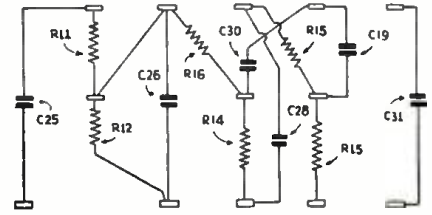

All set voltages are shown on the small trimmer drawing, and it must be noted that some of them cannot be measured with an ordinary 1,000 ohms-per-volt meter. The power consumption of the set is 80 W., peak output is 3.5 W., and undistorted output is 1.75 W.

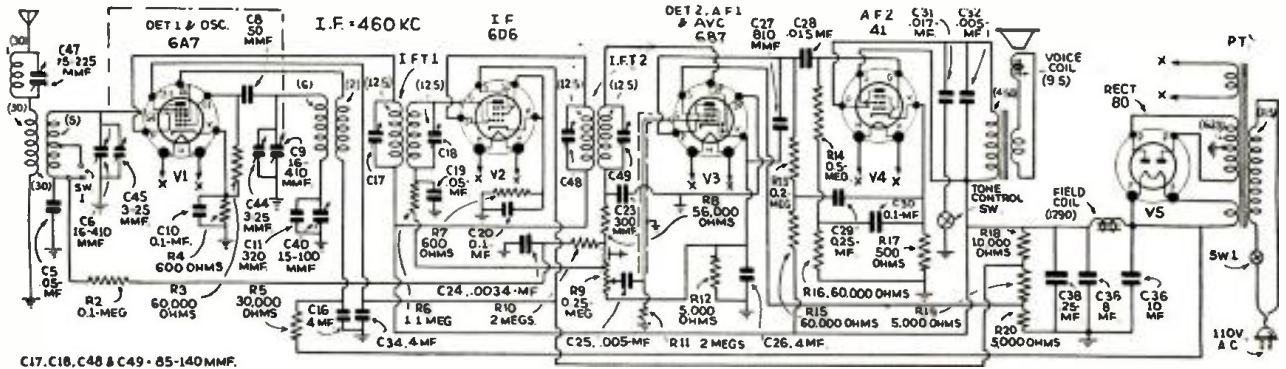

C17, C18, C48 & C49 - 85-140 MMF.

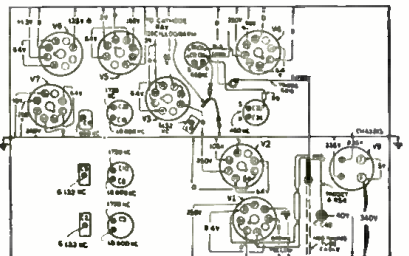

Before aligning this set, use tuning wand to be sure alignment is required. I.F. is aligned at 460 kc., by means of an oscillator. Use an output indicator or an oscilloscope. Adjust trimmers C29, C30, C24, and C25 in that order. Align band A at 1,720 kc., by adjusting C20, C10 and C3 to produce maximum output. Turn oscillator to 600 kc., adjust receiver to resonance, regardless of

RCA VICTOR MODEL C9-4 9-TUBE 3-BAND SUPER.

(Range, 540 to 18,000 kc.; 7 metal tubes; "Magic Eye" tuning; dual-ratio vernier dial; dial illumination changes with bands)

dial setting, and adjust C19. Recheck C20. Band B is aligned at 6,132 kc., by setting test oscillator at this frequency and turning receiver station to this setting. Tune C18 for maximum signal using least capacity necessary for this signal. Check for "image" at 5,212 kc., raising oscillator output if necessary. Return to 6,132 kc. and trim C9 and C2 for greatest output. Change to Band C, set dial to 18,000 kc. and set oscillator likewise. Adjust C16 for peak output, using setting of least capacity. Check for "image" at 17,080 kc. Tune again to 18,000 kc. and adjust C1 and C8 for maximum receiver output.

Alignment with an oscilloscope is more accurate but directions are not included here because, as yet, few Service Men own such equipment.

The small speaker diagram, -A-, on the main diagram shows the actual connections of the speaker, the plug and socket not being included on the main diagram.

The tuning tube circuit requires no care or special adjustment, proper operation being assured by insertion of a good 6E5 tube.

Some of these sets have universal power transformers, which can be used on 100 to 250 V. lines by connection of the proper taps, the taps being located at the top of the transformer case.

The newest type tubes, such as the 6L7 hexode, 6E5 cathode-ray tube, etc. are used in this set with an oscillator circuit which prevents frequency drift, enabling a station to be tuned in and stay steady over long periods of time, regardless of line voltage variations.

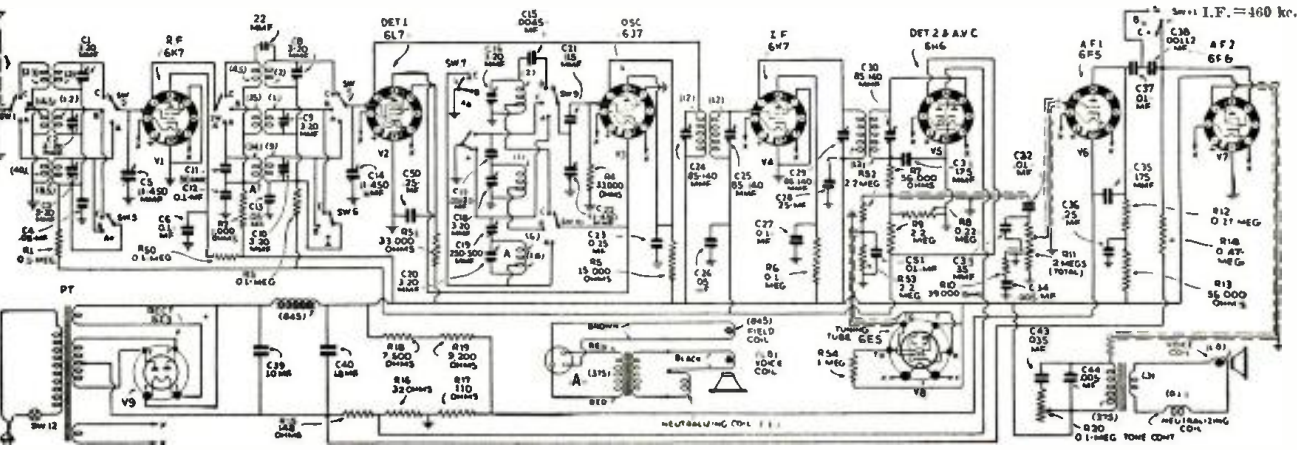



Keep An  
Allied Catalog  
By Your Side-  
It Pays!

# *"We're doing our Radio Buying*



## *100% from ALLIED's catalog"*

**1**

"We're tough customers. We know what we want, the kind of service we want and what price we want to pay. That means we know real value when we see it.

**2**

We've been around—we've done plenty of shopping—and we're through experimenting. Now we've found the right answer for every single one of our radio needs.

**3**

We're doing our radio buying 100 per cent from ALLIED. We know that only ALLIED can give us the quality, the low prices and the real service that we want. That's why we keep an ALLIED Catalog handy—It pays!"

**WRITE FOR**

**YOUR COPY**

**FREE**

Send this coupon now!

ALLIED RADIO CORPORATION  
833 W. Jackson Blvd.  
Chicago, Ill. Dept. D  
 Send me your FREE 1936 Catalog—Radio's  
Leading Supply Guide

Name.....

Address.....

City..... State.....

**Allied Radio**  
CORPORATION  
833 W. JACKSON BLVD., CHICAGO  
"EVERYTHING IN RADIO UNDER ONE GREAT ROOF"

Please Say That You Saw It in RADIO-CRAFT



## AMERICAN-BOSCH MODEL 430T 5-TUBE 3-BAND SUPERHET.

(Ranges—540 to 1,750 kc., 2,400 to 2,600 kc., and 5,900 to 18,200 kc.; 8-tube performance; A.V.C.; Line-O-Lite tuning; Anchored construction)

Adjustment of this set is accomplished in the usual manner, with volume control on full and tone control in the center or treble position. A series condenser of at least .25-mf. must be connected in the high side of the oscillator test leads to act as a blocking condenser. With the oscillator set at 450 kc., align trimmers 4 and 5, then 7 and 8 for best signal. Set wave-band switch in broadcast position. Align dial pointer at maximum mark beyond 540 kc. point with gang fully closed. Set oscillator at 1,500 kc., turn set dial to same point and adjust 13 to maximum. Connect oscillator to antenna through a 200 mmf. condenser and adjust 13 and 17 to best output. Set dial and oscillator at 550 kc., and adjust trimmer 15 at the same time changing the set gang condenser for best output. Readjust 13 and 17 with oscillator and condenser set at 1,500 kc.

The police band is aligned with the center knob on the left-hand position, the

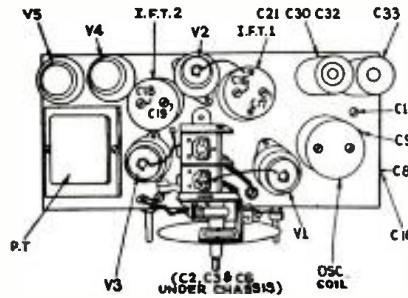

wave-change switch being left in the broadcast position. Set dial at 1,500 kc. (this is position for reception of 2,400 kc.). With oscillator set at 2,400 kc., tune in signal with station selector and set 19 to best position.

With wave switch set on short-wave position, connect oscillator to antenna

through 400 ohm resistor and 200 mmf. condenser (which approximates a short-wave antenna) and set oscillator and dial to 16,000 kc. Adjust trimmers 14 and 18 for best reading on output meter. Adjust station selector and 18 together to best signal. With oscillator set at 6,000 kc., adjust 16 and the station selector together for best output.

The voltages on the tubes are given below:

Tube No	Cath.	S.G.	Plate	Heater
V1*	4.5	75	240	6
V2	3.5	95	245	6
V3	1.4	.....	95	6
V4	18	245	235	6
V5	.....	.....	370	5

\*Anode grid, 140 V. Model 434 has a tapped primary; line is connected to 2 and 3 for 90 V., 1 and 3 for 110V., 2 and 4 for 200V., 1 and 4 for 220 V., 2 and 5 for 230 V., and 1 and 5 for 250 V.

The same chassis may be obtained in two types of cabinets, the one illustrated, and also a console type.

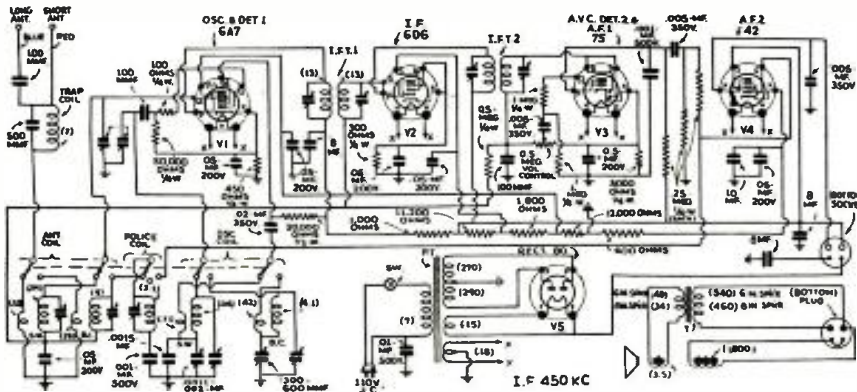

## MONTGOMERY WARD "AIRLINE" SERIES 7GM 7-TUBE HIGH-FIDELITY RECEIVER

(Selectivity control; range from 535 to 18,300 kc.; 3 W. undistorted power output; 4 metal tubes; dual volume control; separate oscillator tube)

Adjustments of trimmers on this set follow standard practice, the use of a calibrated service oscillator being a necessity. All alignment must be done with the selectivity control in the sharp position.

The power consumption from the light line is 68 W. at 115 V. Average sensitivity over the 3 bands is 1.0 microvolt absolute.

Voltages are given in the following table:

Tube Type	Plate Volts	S.-G. Volts	Cath. Volts	Plate Ma.
V1	230	95	3.0	6.4
V2	230	100	9.0	3.2
V3	230	120	3.0	9.0
V4	55**	40	.....	2.3
V5	100	.....	.....	5.2
V6	215	230	17.0*	30.0
V7	.....	.....	.....	34.0

\*Designates read across R16. \*\*Read with a 500,000 ohmmeter. Volume control at maximum and antenna shorted to

ground.

Knockouts are provided on the back of the chassis for addition of parts for a phonograph reproduction circuit.

Power transformers are available for use on any A.C. power line.

The trimmer layout diagram shows changes which have been made in the location of certain trimmers since these sets were first put into production. New locations are also shown.

Right, circuit diagram with switch positions indicated. Below, chassis showing trimmer locations.

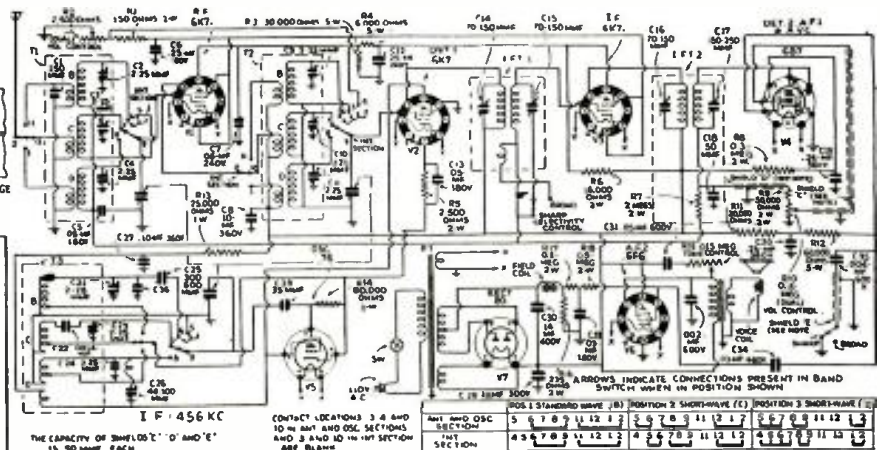
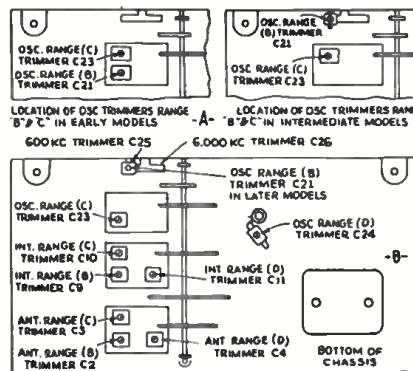

## NEW EQUIPMENT AT THE PARIS RADIO SHOW

(Continued from page 392)

will be remembered that in Europe stations are identified by their location rather than call letters). The radio set in this cabinet is a 9-tube all-wave unit with a push-pull A.F. amplifier having an undistorted output of 9 W.

**"Flood-Lighted" Tuning Scale.** The receiver shown in Fig. D. is a modern set having a very attractive oblong tuning scale, mounted at an angle for easy reading. To further facilitate this, a lamp is mounted over the speaker grille so that the outside of the entire scale is flooded with illumination even in a darkened room. This lamp casts its light on the table in front of the set, so that it can also be used for reading. To the left of the tuning dial is a resonance indicator and to the right is an illuminated scale which tells on which band the set is operating.

**Improved-Fidelity Cabinet.** Several unique methods have been devised for eliminating the distortion caused by resonances of the cabinet or speaker unit which is generally referred to as cabinet resonance—the acoustical labyrinth and floating, damping cones (described in past issues of *Radio-Craft*) are examples of this. A new method has been utilized in the French receiver shown in Fig. E, consisting of a number of Helmholtz resonators, or small tubes which are tuned to the frequencies at which cabinet resonance takes place, by cutting them to a certain length. They absorb part of the output of the set at those particular frequencies thus tending to make the acoustic output uniform.

**Indirectly-Illuminated Full-Vision Scale.** A new German receiver which was displayed at the Paris Radio Show is shown in Fig. F. This receiver is a 6-tube superheterodyne having an unusual dial. This dial which has a translucent, black, oblong scale is mounted over the top of the receiver and speaker. The scale is illuminated from the rear by a small lamp mounted before a semi-polished reflector. A cable drive moves an indicating arrow behind the scale, the shadow of which is visible on the front. Note the peculiar appearance of several of the tubes, especially the second one from the right, which is a combined diode rectifier and A.V.C. tube.

**Variable-Selectivity (adjustable coupling) I.F. Transformer.** Two interesting new coils made their appearance simultaneously with the show. The first of these shown in Fig. G is a variable-selectivity I.F. transformer in which the coil movement is obtained by a "worm drive" consisting of a twisted rod (which looks like a corkscrew) and a flat, stationary strip which acts as a guide for the worm.

**Integral All-Wave Coil-Switch Unit.** The second device of interest is a French version of an all-wave tuning unit. It contains a wave-change switch consisting of a hexagonal drum with 15 contacts on each surface and a set of stationary contacts on an insulating strip. This produces a 15-contact, 6-position switch which is adequate for most switching problems. On either side of the switch are mounted the coils for aerial R.F. and oscillator circuits.

**Modernistic Radio Set.** Another new German set found its way into the Paris Show. This is a set made by the SABA Corp. and, as shown in Fig. H, is housed in an unusual style of cabinet. The front of the set (which is a table-model) is taken up completely with the speaker and tuning dial, which occupy an equal amount of space.

Lack of space prevents a more detailed account of the numerous, remaining items of interest which were displayed at this Paris show.

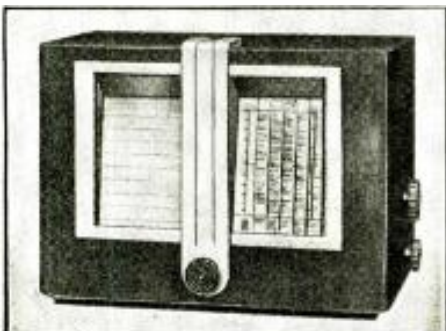

Fig. H. The speaker and dial are both tilted.

# Why The New ELECTRAD CARBON VOLUME CONTROL

## Is Quiet, Smooth, Long-Lived

**T**HE carbon resistance element is permanently fused to the flat outer rim of a vibrationless Bakelite ring. (See illustration).

Over this glass-like surface gently glides a special-alloy floating contact shoe, held in even tension by a flat bronze spring. *No hopping—no chattering.* The more it is used, the smoother it grows owing to the polishing action of the contact shoe.

Current travels in a *straight* path, assuring uniform distribution without short cuts to cause overloading and consequent early breakdown.

The molded Bakelite case extends only 1/2" back-panel. New-type power switch (approved by underwriters) instantly attached or removed by a single screw. Long, easy-to-cut aluminum shaft. *All standard values and receiver manufacturers' exact duplicates.*



This sturdy molded Bakelite ring supports the carbon resistance element. Arrow indicates flat outer rim to which resistance element is permanently fused.

### RESISTOR SPECIALISTS

Featuring:—Quiet Carbon Volume Controls, Vitreous Resistors, Truvolt Resistors and Power Rheostats.

Write Dept. RC-1 for New Catalog

### New 100-Page VOLUME CONTROL GUIDE

FREE, if you send us the flap (part showing specification and resistance) from any new-type Electrad Carbon Volume Control carton, together with your business letterhead or card.



6 3/4" x 9 3/4"  
Address: Dept. RC-1.



# These Splendid Books FREE!

Think of it! 2 books full of invaluable information, to be had for just the mailing costs! One with 20 complete transmitter designs including 12 tested transmitter RF section designs and 8 modulator and speech amplifier designs. Circuits, complete parts specifications, inductances, etc. all included.

Ten complete designs for public address amplifiers in the other book. It includes one for every purpose, from 3 Watts to 30 Watts output, with complete parts lists for each.

These books should be in every amateur's technical library. They are invaluable for reference purposes. Just 22 cents in stamps brings them both to you. Send for your copies today.

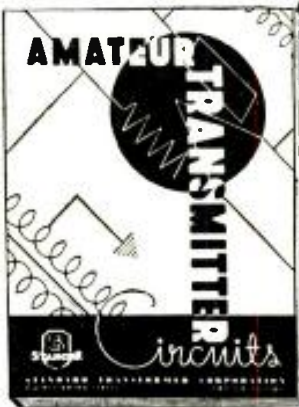

## STANDARD TRANSFORMER CORP.

856 Blackhawk Street,

Chicago, Illinois

### MAIL THIS COUPON!

STANDARD TRANSFORMER CORPORATION,  
Dept. C, 856 Blackhawk Street, Chicago, Ill.  
I am enclosing 12c for Transmitter Manual.  
I am enclosing 10c for Amplifier Manual.

Name \_\_\_\_\_ Address \_\_\_\_\_  
City \_\_\_\_\_ State \_\_\_\_\_

Please Say That You Saw It in RADIO-CRAFT





### THIS WELL-EQUIPPED SHOP SERVICES ALL-WAVE SETS

The shielded test room described in the following interesting letter is a convenience that is rarely seen outside of the research laboratory, but one which the progressive Service Man may well copy.—*Editor*

RADIO-CRAFT, ORSMA Department:

Enclosed find two photos, one showing our rear service room which is used mainly for rush jobs on auto-radio sets, and the other showing our shielded balancing room, which is used for balancing all-wave sets. The shielded room is completely covered by copper screen; the screen joints are soldered, and the screen is grounded. We also filter the A.C. line into the room with a system of chokes and condensers of our own design. Even with the most sensitive radio set it is not possible to get outside interference inside the room.

We also have a service shop in the front of the building for house radio sets and auto-radio receivers upon which we have more time; here also we keep a stock of tubes and parts.

We do wholesale auto-radio service for a majority of the Oklahoma City dealers who do not have their own auto-radio men, as well as wholesale service for Peaslee-Gaulbert Corp., Zenith Distributors.

Our other activities include wholesale and retail radio set and parts sales.

The man in the photo is Mr. H. D. Maxwell, our service manager.

Thanking you for your interest and any consideration you may give us.

CHAS. E. MUSSON,  
Oklahoma City, Okla.



Left, service room used for rush jobs by C. E. Musson. Note that the workman's comfort is considered. Right, Mr. Musson's shielded line-up room.

### A NOTICE TO ORSMA MEMBERS

*This is your page*—its value depends entirely upon your letters, suggestions, criticisms and hints. Why not do *your* part by writing whenever you have a suggestion to offer concerning the Association; a comment concerning any of the letters printed; or anything that you believe will be of interest to other members or of benefit to the entire organization!

Perhaps you have just finished re-vamping your service bench or shop—why not take a snapshot of the new set-up and send it in so that other members can see it on *your* page and benefit by *your* experience?



### BUG HUNT—NEW INDOOR SPORT FOR SERVICE MEN!

RADIO-CRAFT, ORSMA Department:

The following experience took place while servicing a radio set that came out of a restaurant.

Upon unloosening the bolts to get the chassis out, the set was discovered to be inhabited by hundreds of cockroaches. Sliding the set back in, I put it into a large box and, sealing it tightly, took it home with me. On the back porch paper was spread out, the chassis taken out again, and the wild chase began! A few of the vermin dropped on the paper and taking a screwdriver, I tried to fish some more out, but in vain.

*They were inside the windings of the power transformers, chokes, R.F. coils, between variable condenser plates, and since the condenser was of the bathtub type, the bottom was full of them!*

Ammonia was used hoping the smell would drive them out. About 20 popped out but the rest remained.

Scratching my head I was at a loss as to what to do next. Suddenly an idea struck me. We had our gas range in the kitchen going full speed (my wife was baking pies that day), and taking the set I put it on top of the oven. About 5 minutes elapsed when those cockroaches commenced coming out, not one at a time, but in bunches. Somehow the heat seemed to attract them, and no sooner did they hit the oven (they were all aiming to get on the hot side) than they turned over on their backs, emitted a crisp and crackling sound like when one fries pork sausages, and were roasted alive.

About 20 minutes later they were all out of the set and the oven, covered with hundreds of them, looked like a battlefield!

Next the set was checked and (Continued on page 446)

# TECHNICIANS' DATA SERVICE

JOSEPH CALCATERRA DIRECTOR

A special arrangement between RADIO-CRAFT magazine and the publishers of this literature, which permits bulk mailings to interested RADIO-CRAFT readers, eliminates the trouble and expense of writing to each individual organization represented in this department.

2. HAMMARLUND 1936 CATALOG. Contains 12 pages of specifications, illustrations and prices on the new line of Hammarlund variable, mid-get, band-spread and adjustable condensers; trimming and padding condensers; R.F. and I.F. transformers, coils and coil forms; sockets, shields, chokes and miscellaneous parts for ultra-short-wave, short-wave and broadcast operation.

3. HOW TO GET A HAMMARLUND 1936 SHORT-WAVE MANUAL. A circular containing a list of contents and description of the new 16-page Hammarlund Short-Wave Manual, which contains construction details, wiring diagrams, and list of parts of 12 of the most popular short-wave receivers of the year.

4. THE "COMET PRO" SHORT-WAVE SUPER-HETERODYNES. Describes the outstanding features of the standard and crystal-type Hammarlund "Comet Pro" short-wave superheterodynes designed to meet the exacting demands of professional operators and advanced amateurs for a 15 to 250 meter code and phone receiver, but which can be adapted by anyone for laboratory, newspaper, police, airport and steamship use.

5. ELECTRAD 1936 VOLUME CONTROL AND RESISTOR CATALOG. Contains 12 pages of data on Electrad standard and replacement volume controls, Truvolt adjustable resistors, vitreous wire-wound fixed and adjustable resistors and voltage dividers, precision wire-wound non inductive resistors, center-tapped filament resistors, high-

quality attenuators, power (50- and 150-watt) rheostats and other Electrad resistor specialties.

25. LYNCH NOISE-REDUCING ANTENNA SYSTEMS. Complete descriptions and instructions issued by Arthur H. Lynch, Inc., for making all kinds of antennas for broadcast and short-wave reception, with a special supplement covering Ham Antenna Design for transmitting as well as receiving all the amateur bands, including the ultra-high frequencies.

26. LYNCH AUTO RADIO ANTENNAS, FILTERS AND NOISE SUPPRESSORS. This folder describes a complete line of Lynch antennas, filters and ignition noise suppressors designed for auto radio installations. The antenna system is of the under-the-car type for easy installation. It includes data on Hi-Gain matched-impedance transmission lines which make the under-car antenna highly desirable for use with the new "Turret-top" cars.

28. LYNCH SUPER-FILTASTATS FOR AUTO RADIO INSTALLATIONS. Describes and illustrates, with instructions for using, the new Lynch Super-Filtastats which do away with the need for suppressors in auto-radio installations, giving better performance in operation for both the car and radio set.

57. RIBBON MICROPHONES AND HOW TO USE THEM. Describes the principles and operating characteristics of the Amperite velocity microphones. Also gives a diagram of an excellent humless A.C. and battery-operated preamplifier.

62. SPRAYBERRY VOLTAGE TABLES. A folder and sample pages giving details of a new 300-page book, containing 1,500 "Voltage Tables" covering receivers manufactured from 1927 to date, published by Frank L. Sprayberry to simplify radio servicing.

64. SUPREME No. 385 AUTOMATIC TESTER. A technical bulletin giving details, circuits and features covering this new Supreme development designed to simplify radio servicing. In addition to the popular features of Supreme analyzers and tube testers it contains many direct-reading features which eliminate guesswork or necessity of referring to charts or tables.

67. PRACTICAL MECHANICS OF RADIO SERVICE. Information, including cost, features and outline of lessons of the Frank L. Sprayberry course in Radio Servicing, and list of Sprayberry Data Sheets for modernizing old radio equipment.

73. HOW TO ELIMINATE RADIO INTERFERENCE. A handy folder which gives very complete information on how to determine and locate the sources of radio noise by means of the Sprague Interference Analyzer. A description of the analyzer and method of using it is included, together with data on how to eliminate interference of various kinds once the source is located.

74. SPRAGUE 1936 ELECTROLYTIC AND PAPER CONDENSER CATALOG. Gives specifications, with list and net prices on a complete line of wet and dry electrolytic, and paper condensers made by the Sprague Products Co. for radio Service Men, set builders, experimenters and engineers. Information on the Sprague Capacity Indicator, for making capacity tests on condensers and in servicing receivers, is included.

75. SPRAGUE TEL-U-HOW CONDENSER GUIDE. A valuable chart, compiled by the Sprague Products Co. which tells the proper types, capacity values and voltages of condensers required in the various circuits of radio receivers and amplifiers, and how to locate radio troubles due to defective condensers. Includes data on condenser calculations.

76. FACTS YOU SHOULD KNOW ABOUT CONDENSERS. A folder, prepared by the Sprague Products Co., which explains the importance of various characteristics of condensers, such as power-factor, leakage, capacity and voltage in determining the efficiency or suitability of a given condenser to provide maximum filtering and safety in operation.

77. SUPREME 391 P.A. ANALYZER. This booklet describes the features and use of the new Supreme 391 P.A. Analyzer, designed to equip the radio Service Men to cash in on the constantly growing opportunities for service in the sound equipment and public address systems used in movie theatres, schools, churches, auditoriums, etc.



Yes, some people are making money in radio servicing today—*real money!* Because they know all the latest methods, know all the short-cut tricks of the trade, know how to construct the most up-to-date equipment—know how to sell their service at a profit.

Ghirardi gives this information to you—the combined experience of the country's most successful servicing organizations in one convenient book, MODERN RADIO SERVICING.

Just for example, the chapter on "How to Sell Your Service" tells you all about how to dig out prospects, how to break down their sales resistance and make them buy, how to make bigger sales, how to keep your customers, how to turn every opportunity into cash, how to keep your sales and servicing records—everything, in short, about selling, advertising and merchandising your radio service.

But that's only one chapter in this remarkable book! In the other 31 chapters you'll get all the latest dope on the most approved methods and test instruments for servicing new and old sets. The 1935 data on servicing with Cathode-Ray Oscilloscopes is alone worth the price of the book. And the Supplement book contains (among many other things) the "Case Histories" of over 750 receivers and a complete table of i-f's for all superhets (2,790 of them!).

You can't afford to be without MODERN RADIO SERVICING. It belongs on your bench right now. *Clip the coupon and mail it today!*

## MODERN RADIO SERVICING

1300 pgs. 706 illus. 722 Review Questions. \$1.  
**RADIO FIELD SERVICE DATA SUPPL.**  
 240 pages. 43 illus. Flexible binding. \$1.50  
**BOTH BOOKS \$5—if purchased together.**



RADIO & TECHNICAL PUBLISHING CO.  
 45 Astor Place, New York Dept. RC-1

- Please send your Introductory Combination Offer of both books, at \$5, postpaid.
- Please send FREE circulars.

Name \_\_\_\_\_  
 Address \_\_\_\_\_

Occupation \_\_\_\_\_  
 What kind of information do you need most?  Test instruments?  Newest test methods?  Sales and advertising?  Case histories?  Repair methods?



**Radio-Craft Technicians' Data Service**  
 99 Hudson Street.  
 New York City, N.Y. RC-136

Please send to me, without charge or obligation, the catalog, booklets, etc. the numbers of which I have circled below.

2	3	4	5	25	26	28
57	62	64	67	73	74	75
76	77					

My radio connection is checked below:

- Service Man operating own business.
- Service Man for manufacturer.
- Service Man for jobber.
- Service Man for dealer.
- Service Man for servicing company.
- Dealer.
- Jobber.
- Experimenter.
- Professional Set Builder.
- Amateur Set Builder.
- Short Wave Work.
- Licensed Amateur.
- Station Operator.
- Radio Engineer.
- Laboratory Technician.
- Public Address Worker.
- Manufacturer's Executive.
- Student.

I am a:  
 Subscriber  Newsstand reader

I buy approximately \_\_\_\_\_ of radio material a month. (Please answer without exaggeration or not at all.)

Name \_\_\_\_\_

Address \_\_\_\_\_

City \_\_\_\_\_ State \_\_\_\_\_  
 (Please print name and address)

Avoid delay. The catalogs and booklets listed are now in stock and will be sent promptly as long as the supply lasts. Please use this coupon in ordering. The use of a letter causes confusion and delay.

Please Say That You Saw It in RADIO-CRAFT





**Hurry, Service Dealers, ask your jobber how to get all or any of N. U.—Rider Manuals Free on SPECIAL LIMITED OFFER!**

... and remember, this is only one of the many pieces of equipment you can get free with National Union tube purchases. You'll have to act fast if you want to get Manuals on the special basis, but, whether you do or not, be sure to get full details of other free offers.

**NEW VOLUME SIX INCLUDED**      **OFFERS EXPIRE DEC. 15, 1935**

**Mail Coupon**

NATIONAL UNION RADIO CORP. OF N. Y.  
570 Lexington Avenue, New York, N. Y.      RC 136

Tell me what shop equipment I can get, how I can get it and where!

Name \_\_\_\_\_  
Street \_\_\_\_\_  
City \_\_\_\_\_ State \_\_\_\_\_

**SEND FOR THIS FREE CATALOG**

Check full of BARGAINS in RADIO SETS, Loud and Short Wave Apparatus, Servicemen's Repair and Replacement Parts, Electrical Appliances and hundreds of Miscellaneous Specials at TREMENDOUS SAVINGS. Get this big new Bargain Book. It's absolutely FREE without obligation—just dress on a post card.

**RADIO CIRCULAR CO., INC.**  
225 Varick St., Dept. R. C., New York, N. Y.

**YOUR OBSOLETE ANALYZER "PRECISION" MODERNIZED**

INTO A TWO METER MASTER ROTARY SELECTIVE SYSTEM

**Write for our Plan**  
Mention Model Number of Your Old Analyzer

**PRECISION APPARATUS CORP.**  
Modernization Division Dept. C  
821 E. N. Y. Avenue      Brooklyn, N. Y.

**HOW TO MAKE A COMPLETE 5-METER PORTABLE STATION**

(Continued from page 396)

grid coil must be adjusted so that the plate current is about minimum at center-scale position of the plate tank condenser. This adjustment is made without antenna load. The method of coupling the antenna to the plate tank is not the best, but is simple, and really not as unbalanced as it appears. The oscillator will draw about 20 to 25 ma. unloaded, and this increases to around 30 to 35 ma. fully loaded. This means an input of 6 to 8 W. at 200 V., which is plenty to put a strong signal on the air.

**CONCLUDING DETAILS**

The transmitting condenser shown in the photo (C12 in Fig. 1) is of the split-stator type, made from a 75 mmf. standard model. It was originally intended to ground the rotor but this was found unnecessary, so a single section 15 to 20 mmf. unit (as specified in the list of parts) will do just as well.

The grounded and "hot" filament battery leads, the "B+" and the control relay lead, go to a 4-prong socket on the rear of the box. The control relay which is operated by a switch on the regeneration control serves to turn on the genemotor. This saves running a long lead to the set, which with the 4 A. or so of current taken by the motor-generator would lower its voltage somewhat. The relay is simply an auto cut-out, re-made slightly.

The power supply, with its filter, is located in another 5 x 6 x 9 in. metal box, with a shielded cable running to the set. The filter choke is a low-inductance unit as shown, but has been found adequate. The R.F. chokes in the power supply leads are all needed, as they serve to prevent the commutator ripple from disturbing the receiver.

The antenna generally used with this set is a 4-foot vertical rod, grounded at the lower end. The single wire feeder taps onto the rod, about 1 ft. from the grounded end. Raising the tap towards the top increases the coupling. It is best to make the antenna in two sliding sections, so that it may be adjusted for proper wavelength.

It is well to mention in conclusion that this set is a real transmitter, and as such, requires that the operator hold a Federal Radio License for legal operation. (An inquiry on a postal addressed to: Federal Communications Commission, Washington, D.C., will bring the address of your local Radio Supervisor, from whom you will be able to obtain all requisite forms. The book, "How to Become A Radio Amateur Operator," 50c, Popular Book Corp., 99 Hudson St., N. Y. C., contains useful information on initial steps.—Editor) The range under certain conditions may be as high as 100 miles, so don't try "bootlegging"!

**LIST OF PARTS**

- Two Hammarlund 50 mmf. variable condensers, C1, C11;
- Two Hammarlund 20 mmf. variable condensers, C3, C12;
- One Hammarlund 3-35 mmf. trimmer, C4;
- One Cornell-Dubilier 100 mmf. mica condenser, C2;
- One Cornell-Dubilier .005-mf. mica condenser, C5;
- Two Cornell-Dubilier .1-mf. paper condensers, C6, C10;
- Two Cornell-Dubilier 5 mf., 50 V. electrolytic condensers, C7, C8;

Fig. 2. Details and dimensions of the box.

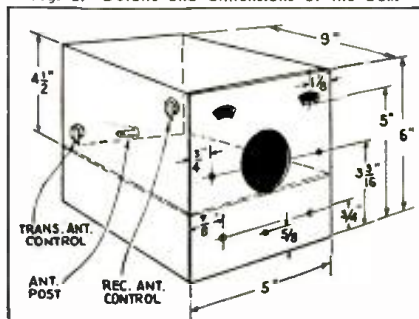

- One Cornell-Dubilier .001-mf. mica condenser, C9;
  - Two Cornell-Dubilier 8 mf. filter condensers, C13, C14;
  - One Electrad .1-meg. variable carbon resistor, R2, with switch, Sw.1;
  - One Electrad .5-meg. variable carbon resistor, R5, with switch, Sw.2;
  - One IRC .5-meg., 1/2-W. resistor, R1;
  - One IRC 2,000 ohm, 1/2-W. resistor, R3;
  - One IRC 3,000 ohm, 1/2-W. resistor, R4;
  - Five Hammarlund midret R.F. chokes, RFC1-5;
  - One Blan changeover ("send-receive") relay No. 1;
  - \*One microphone and plate-to-grid transformer, T1;
  - \*One class B input transformer, T2;
  - \*One class B 79 to 5,000 ohms transformer, T3;
  - One Hammarlund 955 isolantite socket;
  - One Hammarlund 7-brong isolantite socket;
  - One ICA 4-prong socket;
  - Two ICA 6-prong sockets;
  - Two ICA 5x6x9 in. boxes (one for set and one for power supply);
  - One ICA mounted 5-meter coil;
  - Four ICA small bar knobs;
  - Two ICA small fluted knobs;
  - Two ICA single-circuit jacks;
  - One RCA type 955 "acorn" tube, V1;
  - One Raytheon RK 34 ultra-short wave tube, V4;
  - One RCA type 41 tube, V2;
  - One RCA type 79 tube, V3;
  - \*One motor-generator "B" supply unit, 250V., 50 ma.;
  - \*One Standard Trans. Corp. low-resistance choke;
  - One Blan generator-control relay No. 2 (see text);
  - One 2-in., 100-ma. meter;
  - Wire, hardware, and incidental items.
- (\*Name of manufacturer upon request)

**INTERNATIONAL RADIO REVIEW**

(Continued from page 393)

issue of *Le Haut Parleur*, a French publication, pictures of these new coils were shown (Fig. 1). In appearance, they resemble vacuum tubes, having glass envelopes and bases similar to them. The coils are enclosed in the glass bulb, in place of the usual tube elements and the glass envelope is evacuated and sealed.

Coils, for short-waves, broadcast frequencies and intermediate frequencies are obtainable.

**TWO NEW ENGLISH SPEAKERS**

A NEW loudspeaker described in a late issue of *Practical and Amateur Wireless*, has been designed to supply the greatest possible bass response by supporting the diaphragm between resilient pads held by a perforated chromium grille. Thus, there is no "restoring" force, and the diaphragm may be considered as fully floating. (See Fig. D.)

The second speaker was described in *The Broadcaster and Wireless Retailer*. It is a permanent magnet dynamic unit of large proportions which is designed to supply unusual definition to the lower frequencies. In order to permit correct matching to different types of output tubes, a switching arrangement with a series of taps on the coupling transformer primary is incorporated.

Since this speaker is a "high-fidelity" unit, provision for high frequency radiation is made by the addition of a tweeter in the speaker chassis. This tweeter operates through the pole pieces of the bass speaker—a very unusual procedure. (See Fig. E.)

**RADIO MONTH IN REVIEW**

(Continued from page 391)

with the very important task of keeping the station running smoothly by eliminating trouble in the water cooling system.

Formerly, a mechanic employed at this radio station was given the task of cleaning the circulating water pipes periodically of alkaeous plants which clogged them up.

This mechanic who kept goldfish as a hobby requested the chief engineer of the station to give him permission to put some of the fish in the water cooling system to eat the algae. The success of this experiment was surprising—the fish (144 in number) ate the algae in short order!

Please Say That You Saw It in RADIO-CRAFT

## MAKING A TUNED ALL-WAVE ANTENNA

(Continued from page 397)

signals and for maximum efficiency, the lower the high-frequency resistance of this wire, the greater will be the pick-up. Therefore, the cage type is recommended in preference to the single-wire aerial. For all-wave reception two 20½-ft. cages, employing 4 lengths of wire in each cage held by 4 or 5 aerial spreaders, make an ideal aerial.

### TRANPOSED TRANSMISSION LINE

The next unit of the antenna system is the "transposed transmission line." Theoretically this is used to transfer the signal from the aerial to the coupling device of the receiver, and any external noise or signal picked up by the transmission line is killed off by neutralization through phase reversal. Thus, the two wires of the transmission line being close together pick up the noise or signal in the same phase, but as the wires are twisted and the current in the respective wires is 180 deg. out of phase, the pick-up is nullified. Either bare wire separated by "transposition blocks," or else twisted, rubber-covered wire, ordinarily is used for this purpose, and herein is a prolific source of signal loss. The impedance of this type antenna is about 70 ohms at the center, and if the impedance of the transmission line is close to this value a good match results with very little loss. On the other hand, if the impedance of the transmission line is approximately 450 ohms there is at least a 3 db. loss, which means in non-technical language a 50 per cent loss of signal energy.

Transferring the signal from the transmission lines to the receiver is the next proposition. To do this with a minimum of loss the only practical solution is to include a variable tuned system. Figure 1 shows a complete all-wave antenna system that can be used with any type of receiver. Condensers C1 are used to resonate the transmission line. This aids materially in reducing image interference when using superheterodynes that are afflicted with this malady and furthermore increases overall selectivity. Condenser C2 is used to resonate the coil L1 which is the primary of the coupling transformer.

The coupling to the receiver should be entirely magnetic since any capacitive coupling would cause the transmission lines and antenna to act as a T-type antenna to ground, through the receiver. This would cancel the noise-reducing features of the doublet and the noise-to-signal ratio in a noisy location may prevent weak signals from being heard.

### THE "FARADAY SCREEN"

To prevent any capacitative coupling to the receiver a "Faraday" or electrostatic shield is inserted between the primary and secondary of the coupling transformer. Electrostatic shielding is quite different from the usual shielding in that it must be free from eddy currents or "short-circuited turn" effects. This shield or screen is made in the form of a grid of parallel wires insulated from each other except for a common connection at one end of each wire.

Suitable material to make a screen of this arrangement, is from the celluloid supported R.F. coils that were popular a few years ago. To make this shield, cut across the coil and flatten same to form a rectangle, remove the insulation from one end of the wires and solder a wire across these ends for the ground connection. If necessary, screening of this type can be made by winding the wire on a piece of celluloid (40 T. per in. using No. 26 D.S.C.) temporarily supporting this on a cylindrical form. After the screen is wound it should be coated with duco cement to hold the turns securely in position. When thoroughly dry the same procedure is followed as with the coil. The coil (L2) is then placed in a small shielded box with an opening on one side to which is affixed the electrostatic shield.

The tuning unit is placed in a totally-shielded aluminum box, which should not be of pigmy dimensions. The tuning condensers and coils are mounted on stand-off insulators, which are fastened to the base of the box. All controls are brought to the front panel by the

use of ¼-in. rods which are insulated from the condensers with insulated flexible couplers. For simplicity and ease of construction the shield for L2 is a small aluminum box with grooved corner posts. One of the sides of this box is removed and the electrostatic screen is inserted in its place, the bottom of the screen being grounded and the top left protruding above the top of this small box.

The coil L1 is wound with 60 T. of No. 22 D.S.C. wire and is tapped at the 60th, 30th and 16th turns. A 3-point selector switch is used to select the taps for the various frequencies.

The signal strength delivered to the receiver will depend on the coupling between L1 and L2, also the selectivity of the tuning condenser C2. If the coupling between these coils is loose, condenser C2 will tune very sharp and will have to be retuned every time the receiver is tuned to a different station. This, however, is a very desirable feature especially if the receiver is not very selective.

Complete protection against lightning is provided by including a double lightning arrester. This is placed in the tuning unit box. One end of each arrester is connected to the transmission line and the other ends are connected to ground.

### LIST OF PARTS

- One Lynch 20½-ft. cage doublet;
- One Lynch double lightning arrester;
- One length of Arthur H. Lynch "Giant Killer" cable;
- Eight stand-off insulators;
- Three Hammarlund ¼-in. flexible couplers;
- Three Hammarlund 200 mmf. tuning condensers;
- Two Blan shield cans;
- One Blan Faraday shield;
- Three Blan tuning dials;
- Five Blan name plates.

## REPRODUCERS FOR THE S.-W. RECEIVER

(Continued from page 400)

distance of 6 ft. from the reproducer. Disconnecting the unit demonstrated that most of this hum came from the receiver and not from the speaker. With the unit shown at A, a hum so faint as to be scarcely audible could be detected at a distance of 2 ft. from the speaker. This hum disappeared completely when the receiver was disconnected.

Tone was tested by listening to a symphony concert. Notes from the highest-pitched instruments were clear and clean. Notes from the bass instruments were full and resonant on both reproducers.

On amateur bands C.-W. reception was tested. Reception on both speakers was excellent and the model at B was found to have a clear, snappy tone that renders it an ideal one for the amateur who must make every dollar do double duty. It is interesting to note that with this model particularly, a certain amount of A.F. selectivity may be secured, when listening to two interfering C.-W. signals, one low and one high in pitch. Since this speaker has a very small baffle area the low-pitch signal will be attenuated somewhat, making the high pitch signal seem to stand out more clearly.

## METAL TUBES AND THE NEW S.-W. RECEIVER

(Continued from page 400)

necessary, it seemed a good time to look the situation over pretty carefully. So we started with a clean sheet of paper and a fresh viewpoint, and listed the features an ideal receiver should have. The resulting tabulation is given in Table I.

There is the list, And as often happens when you know just what you want, there is the answer, too. Short leads, individual shields, and no idle coils in circuit mean only one thing—plug-in coils. "Shifting by a knob on the panel" means just that—a mechanism to plug in the coils automatically, by a twist of the wrist. And "exact" shifting means that mechanism must be accurate, positive and rugged.

Please Say That You Saw It in RADIO-CRAFT

# A NEW TUBE TESTER

## RELIABILITY AT LOW COST



MODEL 430

DEALER'S PRICE  
**\$18.00**

A new emission type Tube Tester that tests all metal and glass-metal tubes. Features:

Tubes for value and shorts are tested under actual load. Leakage and short test. But four simple operations required. Shadow-type A.C. meter for adjusting line voltage. Double Grid Cap for Metal and Glass-Metal tubes. Handsome portable quartered oak case, removable cover, with all-metal sloping panel having silvered letters on black background. Especially constructed against obsolescence.

Model 430 complete with Triplett moving coil instrument having direct reading GOOD-BAD scale, protected against damage. Net Dealer Price **\$18.00**

Model 431—same as Model 430, except has Readrite direct reading GOOD-BAD meter. Dealer Net Price **\$14.40**

Readrite also manufactures all types of testers used for servicing radio sets, including: Set Testers, Tube Testers, Resistance, Continuity and Capacity Testers, Point-to-Point Testers and inexpensive Indicating Meters, used by thousands of Hams, Industrials and Servicemen.

SEE YOUR JOBBER



**MAIL COUPON NOW**

Readrite Meter Works  
161 College St.,  
Bluffton, Ohio.

Please send me more information.....

..... Model 430 ..... Model 431

..... Catalogue

Name .....

Address .....

City..... State.....





"Smooth job - eh?"

Old Man CENTRALAB is at the wheel my fraand! Arch-enemy of noise . . . as smooth as an ambassador . . . he takes those noisy "sets" and presto: the customer pays with a smile.

Thousands (yes thousands) of servicemen everywhere carry a small stock of CENTRALABS at all times . . . and they can service practically any job . . . better than ever before.



Every Radio Service Man should be a member of the Institute of Radio Service Men

**Centralab**  
MILWAUKEE WIS.  
RADIOHMS SUPPRESSORS  
FIXED RESISTORS

**THE NEW**

**ANSLEY DYNAPHONE  
PLAYS 16-INCH RECORDS**

Excellent for broadcast transcription records and all smaller discs of any speed. Microphone jack provided. AC-DC. Crystal pick-up (patented.) Weighs 35 pounds. \$89.50, ready for use.

**ANSLEY RADIO CORPORATION**  
100 W. 57th St., New York, N.Y.

**Ken-Rad  
Radio Tubes**

Ken-Rad Glass and Metal Radio Tubes are made to give clear, dependable reception. They satisfy customers and build good will for dealers. Write for full information.

**THE KEN-RAD CORP., Inc., Owensboro, Ky.**  
Division of The Ken-Rad Tube and Lamp Corp.  
Also Mfrs. of Ken-Rad Incandescent Electric Lamps

**A 5-METER ANTENNA DIRECTIVE-BEAM ARRAY**

(Continued from page 397)

**INCREASING FIELD INTENSITY**

Two ways are open to increase the field intensity, as follows: (1) increased power; and, (2) the use of a directive-beam antenna. The big advantage of the latter means is that it will concentrate the radiation of the transmitter in the direction desired with a great increase in the effective power in that direction—without appreciably increasing the power consumption of the transmitter.

For reception, the angle of the antenna and its direction should be determined for best results. It will vary from the vertical to the horizontal and adjustments should be made accordingly. Experiments have shown that vertically polarized waves radiated from the transmitting antenna have been received best with receiving antenna placed in every position from vertical to horizontal planes. This seems to indicate that the polarization of the radiated wave is continually changing as it passes through different media and encounters obstacles.

At the lower frequencies, the use of directive beam antennas, because of the size, amount of space, and expense involved, is prohibitive. With the ultra-high frequencies, the physical dimensions are more workable, permitting even very complicated directive antennas to be used. The degree of directivity of the beam-array antennas will vary directly as the number or elements used. Since an attempt to describe all types of directive antennas would be extremely lengthy, this article discusses only one fundamental design together with its physical dimensions and spacings (see Fig. 1). Approximate specifications given here are for the 56 mc. to 60 mc. band. However, they can be used for the 2 1/2 and 1 1/4 meter bands as well, by dividing by 2 for 2 1/2 meters and by 4 for 1 1/4 meters.

This directive antenna system, as shown in the photo, uses "parasitic" reflectors (as contrasted with "power" reflectors, described in past issues of Radio-Craft) to cancel the backward radiation from the antenna conductors. In general, the length of the reflectors will be greater than the antenna, and should be spaced about 1/2-wavelength in back of the antenna, and 1/2-wavelength from the other reflectors. A very practical way for determining the length of antenna conductors very closely is to multiply wavelength by 1.56, which will give the length in feet of a 1/2-wave Hertz antenna. This figure has been found very reliable and will come close to the actual measured wavelength.

**TUNING THE ARRAY**

Accuracy of measurement of the different elements of the array and spacing is very important so that the proper phase relationship and radiation pattern (see Fig. 2—this is from Terman) is obtained. Tuned feeders should be approximately 1/2-wavelength of the operating frequency. The exact tuning of the feeders is achieved either by parallel-tuning across the antenna coil, or with a condenser in series with each feeder lead.

After the antenna is erected and spaced properly, each element of the array is adjusted to the exact length, and the feed line is tuned to the desired frequency, as indicated in Table I. There are several ways to determine when the correct adjustments have been made.

A simple and effective means of making accurate adjustment is to have someone with a transceiver locate himself somewhere in front of the array and adjust conductor length until maximum signal strength is obtained. Then, have the person take this same receiver, tuned to the same frequency, directly in back of the reflectors, and have him advise you when signals are at a minimum while the reflectors are being adjusted.

Table I

Pre-frequency in Mcs.	Wave-length Meters	Ant. Length LA	Reflect. Length LR	Ant. Spacing S1	Ant.-to-Ref. S2
56	5.357	8' 4"	8' 7"	8' 9"	4' 4 1/2"
57	5.263	8' 2 3/4"	8' 5 1/2"	8' 7 1/2"	4' 3 3/4"
58	5.172	8' 0 1/2"	8' 3 3/4"	8' 5 3/4"	4' 2 3/8"
59	5.085	7' 10 3/4"	8' 2"	8' 4"	4' 2"
60	5.0	7' 9"	8' 0 1/2"	8' 2 1/2"	4' 1 1/4"

Please Say That You Saw It in RADIO-CRAFT

**A COMPLETE 5-METER TRANSCEIVER "STATION"**

(Continued from page 399)

ing to make a tube circuit oscillate satisfactorily around 5 meters were increased when desiring to employ the self-same tube as a receiving detector (when the switch is operated) that would regenerate properly and have good sensitivity. Sometimes the constants employed with the tube when used as an oscillator, would seriously impair the efficiency when switched to "receiving" or vice-versa. Time, patience and stick-to-itiveness finally overcame all these obstacles—with the net result that the circuit shown in Fig. 1 (with all values indicated) was finally adopted.

Now, concerning the design features of this transceiver. Studying Fig. 1 it will be noted that a 19 tube, composed of two triodes, is employed as the oscillator. A tuned plate arrangement was found to be the most satisfactory in this case, and the circuit is that of a push-pull oscillator variety. The grid coil is untuned, and is closely coupled to the plate inductance. Output connections to the two feeder terminals in front are made through two fixed mica condensers (.002 mf.) from the tank or plate coil.

When receiving, the first 19 tube is employed as a super-regenerative detector that is easily controllable. This type of circuit has been found to be the most efficient for reception of extreme high frequencies. The tuning characteristic of this circuit is such as to compensate for any frequency drifting that may occur at the transmission end. The detected signal is amplified by the first audio (30 tube) stage and then the class B (19 tube) stage. This amplification insures receiving most signals with, at least, proper headphone volume.

The adjustments of this instrument are very few, as a matter of fact they are confined to the placement of the clips which connect to the feeder antenna terminals. These are set for maximum output, which may be determined by placing a small neon bulb on one terminal.

**LIST OF PARTS**

- One Tri-Test special cabinet (steel) and chassis;
- One 15 mmf. midget variable condenser;
- One Tri-Test transceiver tank coil L1;
- One Tri-Test transceiver grid coil L2;
- One Tri-Test special input transformer (input for mike and audio use)—T1;
- One Tri-Test class B input transformer T2;
- One Tri-Test output transformer T3;
- One 140 mmf. midget variable condenser (regeneration control);
- Three .002-mf. fixed mica condensers;
- Three .002-mf. fixed mica condensers;
- One 100 mmf. fixed mica condenser;
- One 1 meg., 1 W. resistor;
- One 0.2-meg., 1 W. resistor;
- One 5,000 ohm, 1 W. resistor;
- One 1 ohm 10 W. resistor;
- Two Birnbach small standoff insulators;
- One Tri-Test 4 P.D.T. switch;
- One phone jack;
- One mike jack;
- One battery cable;
- One bakelite extension shaft, for mechanical coupling to tuning condenser;
- Two Isolantite 6-prong wafer sockets;
- One Isolantite 4-prong wafer socket;
- Two coil clips;
- Two National Union type 19 tubes;
- One National Union type 30 tube;
- Miscellaneous, such as hardware, knobs, etc.

The underside of the transceiver chassis.

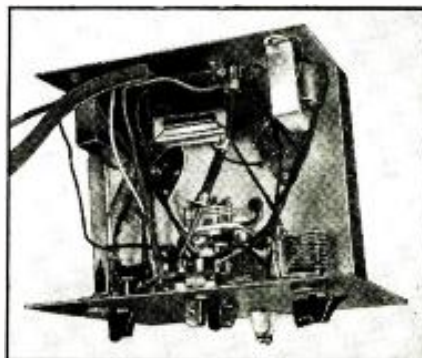

## A 3-TUBE "SINGLE SIGNAL" S.-W. SUPERHETERODYNE

(Continued from page 399)

A.F. receiver, the "Super-Gainer" can be quickly and easily built to give practically the full "single-signal" C.W. selectivity, and all the gain of much more expensive superhets.

How all this is accomplished is best explained by the circuit for the battery model shown in Fig. 1A (the A.C.-D.C. circuit is a little more involved, hence the battery circuit is used for explanation of operation).

Signals are fed from an antenna through the usual low-capacity (twisted hook-up wire) feed to the tuned grid circuit of the 6C6 first-detector. This 6C6 is hooked up as the conventional "electron-coupled" regenerative detector, regeneration being controlled by a 50,000 ohm screen-grid potentiometer.

To the suppressor-grid of this 6C6 first-detector is connected the 76 oscillator plate (or preferably grid). This is pure electron coupling of a stable, harmonic-free triode oscillator having all the stability of electron-coupled oscillators, without, however, their disadvantages and prolific harmonic generation—good in a transmitter but bad indeed in a receiver.

The 6C6 first-detector feeds a tuned primary and secondary iron-core I.F. transformer tuned to anywhere between 450 and 500 kc. The two very high-Q tuned circuits of this I.F. transformer contribute about as much selectivity and almost as much repeater gain as two ordinary air-core I.F. transformers would. But here again regeneration is used to increase gain to any desired degree and selectivity up to single-signal proportions—where it is in terms of cycles, not kilocycles.

The first section of a 79 dual-triode is used as the regenerative second-detector. Regeneration is provided by connecting the I.F. transformer secondary between control-grid and cathode, with the impedance of R.F. choke L5 between cathode and "B," or its plate return.

The second triode section of the 79 tube is the A.F. amplifier, resistance-coupled to the first 79 triode section (second-detector), and terminates in the tip-jacks for headphones.

In the A.C.-D.C. model, Fig. 1B, a 12Z3 rectifier delivers 115 volts D.C. to the single-section filter consisting of filter choke ch. and 2 condensers of 16 and 12 mf. Filament current is obtained through the use of a resistor-cord-plug of the type usual to A.C.-D.C. sets. Hum is zero due to ample filtration and no possibility of A.F. induction.

### LIST OF PARTS

- One Silver 13J 10 mmf. two-gang condenser;
- One Silver pierced chassis and front panel;
- \*One 4 in. dial and decimal indicator;
- Four 1 1/4 in. Readrite pointer knobs;
- \*Two volume indicator plates;
- \*One Det.-Cond. plate;
- \*One Osc.-Cond. plate;
- \*Two J14 150 mmf. condensers;
- \*One 450-500 kc. iron-core I.F. transformer;
- \*Two 4-pin sockets;
- \*One 6C6 socket with shield base;
- \*One 76 socket with shield base;
- \*One 79 socket with shield base;
- \*Three aluminum tube shields;
- One Centralab 50,000 ohm potentiometer, with switch;
- One Centralab 2,000 ohm potentiometer;
- One Silver 17J regeneration inductance;
- \*Three tip jacks;
- Two Silver .1-mf. paper condensers;
- Two Silver .01-mf. paper condensers;
- One Continental Carbon 1,500 ohm 1/2-W. resistor;
- Two Continental Carbon 50,000 ohm 1/2-W. resistors;
- Two Continental Carbon 25,000 ohm 1/2-W. resistors;
- One Continental Carbon 1,000 ohm 1/2-W. resistor;
- One Continental Carbon .1-meg., 1/2-W. resistor;
- One Silver 25 mf. electrolytic condenser;
- \*One .002-mf. mica condenser;
- \*One 50 mmf. mica condenser;
- Two grid clips, hookup wires, screws, nuts, etc.
- \*One 3-25 mmf. mica trimmer cond.;
- Add for A.C.-D.C. operation**
- One Silver 150 ohm resistor-cord and plug;
- One Silver C1056 filter choke;
- One Silver dual 12-16 mf. electrolytic condenser;
- \*One 12Z3 4-pin socket.

(\*Names of manufacturers upon request.)



## A New Service Course for Servicemen! For Men Already in the Field . . . We Offer This New Course In *Service* and

### PUBLIC ADDRESS ENGINEERING

The man who realizes that his pencil can be as important as his pliers, is the man who would rather be a Service ENGINEER rather than a Service MECHANIC. This complete course teaches theory plus the principles of Receiver Design, so that with full knowledge and less time, the TRAINED Serviceman uses less "guess work," which results in time saving, better performance and greater earning capacity.

**Just Off the Press!**  
**NEW 48-PAGE ILLUSTRATED BOOKLET - - - - - FREE!**

A brand-new catalog that contains many actual photos of our extensive laboratories and equipment. It gives complete outlines of all our home-study and residence courses and all details regarding the school, faculty and prices. Write for your copy today.

### CAPITOL RADIO ENGINEERING INSTITUTE

14th and Park Rd. Dept. RC-1 Washington, D. C.



## A SIMPLE 2-TUBE A. C. SHORT-WAVE CONVERTER

### SELF POWERED

(Designed by ROBERT G. HERZOG)

This latest creation of Thor's offers outstanding value and performance. Covers from 19 to 54 and 65 to 200 meters. With positive contact band selector switch.

**Complete kit, as shown**

Unwired and less \$6.95  
tubes, cabinet 49c extra

Special: FREE DIAGRAM sent upon request for any of the THOR Amplifier or Tuner Kits.

MAIL ORDERS PROMPTLY FILLED

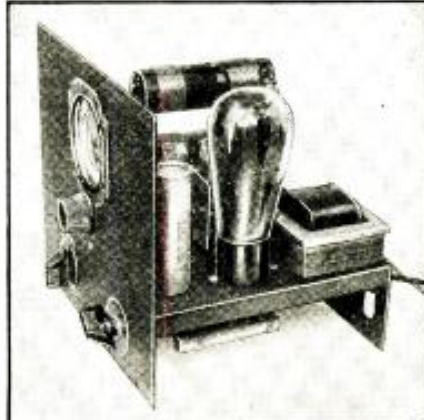



167 GREENWICH ST. NEW YORK, N. Y.

## 5-METER PORTABLE 3-TUBE TRANSCEIVER

### All Battery Operation—Completely Independent of Power Supply

Newly designed—this combination transmitter and receiver is rapidly being accepted by amateurs and veteran wireless men. Has unlimited applications in diversified fields as a means of reliable communication. Employs push-pull oscillator circuit, 2 stage audio amplifier (one is push-pull class B) for receiving and phone modulation. Instant changeover from transmitting to receiving. Total weight less than 19 lbs.

Transceiver wired, less tubes, microphone and batteries. **\$15.25**

Complete Kit of Three Tubes (1-30, 2-19's) **\$1.56**

Complete Batteries (3-45 B's, 2-No. 6 cells, 1-4.5V microphone battery and 1-7.5V biasing battery) **\$4.50**

1-RCA Hand Mike (French Phone and Mike, extra) **\$1.10**



Write For Our New Catalogue. Over 50,000 Radio Bargains

### TRY-MO RADIO COMPANY, Inc.

85 Cortlandt Street, N. Y. C.

## To Readers of RADIO-CRAFT

### FREE POST CARDS MAY BE HAD UPON WRITING TO PUBLISHERS

These postcards make it easy to answer advertisements which appear in RADIO-CRAFT, without cutting valuable data which you may wish to save.

Many times manufacturers request you to "clip the coupon" when answering their ads. Often this means destroying part of an article on the reverse page you may need later for reference. Save your RADIO-CRAFT issues complete. If you should ever want to see bound volumes, or certain copies of RADIO-CRAFT, the resale value of uncut issues is very much higher than that of mutilated ones. So send for a supply of these free post cards and use them in answering all RADIO-CRAFT advertisers.

## SERVICEMEN

NO LONGER NEED YOUR PEAK RECEIVERS BY EAR

### NEON OUTPUT INDICATOR

Connects direct to voice coil. Complete with test leads and instructions. Circular on request.

LIST PRICE \$6.50 NET

## \$3.85

GLOBE MFG. Co.  
Box 4561-Phila. Pa.



Please Say That You Saw It in RADIO-CRAFT



# HERE'S THE **L & L** LINE OF **Modern Testing Equipment**

## Model 22 ALL-PURPOSE TUBE TESTER



Tests new all-metal and semi-metal tubes. Neon, Short and Leakage Test-er. Condenser test-er. Indicates on Neon. 3 1/2" Meter D'Arsonval type. 2% accuracy. ENGLISH READING METER in com-bi-ly with NEON tube. SHOR-T-LEAKAGE-NOISE test gives positive verdict as to worth of tubes.

LEAKAGE TEST is correctly balanced and will not class as defective tubes that are good. Excludes with Model 22. Accurate LINE VOLTAGE CONTROL by 11 point switch which allows uniform tube readings. THE MODEL 22 TESTS THE INDIVIDUAL ELEMENTS OF ALL DOUBLE PURPOSE TUBES. Does not deactivate low voltage types. PORTABLE. SELECTOR SWITCH al-lows rapid accurate testing with provisions for testing 6P7 etc., and future types with electrodes other than normal. Silver lettered bakelite panel. Quar-tered Oak Portable case. Wt. 15 lbs. Model \$23.75  
22-Dealer's and Servicemen's Net Price.....

## Model 23 NEW L & L COMBINATION

Identical in general appearance with Model 22. COMBINES POPULAR L & L MODEL 22 TUBE TEST-ER WITH A VOLT-OHM-MILLIAMMETER. Super-sens-itive 0-2000 Ohms per Vt. Allows Testing and Servicing a Radio Instrument with ONE Compact, Inexpensive Unit. Volt-ohm calibration on meter; Test prods included. The "23" tester consists of a "22" Tube Tester provided with an 0-500 Micro-Ammeter which allows all voltage and ohm measurements to be made at 0-2000 ohms per volt sensitivity. Voltage range, 0-5, 0-2.5, 0-7.5. Ohm range, 0 to 200,000 with 1 1/2 volt built-in battery, though this can be extended to 2 meg ohms with an external 15 volt battery. Ideal for auto work, as all tests can be made with one unit. Pin jacks in upper right hand and toggle switch in lower left; controls all tests. When toggle is thrown to volt-ohm side shunt is removed from meter converting it to an 0-500 micro-ammeter. This SUPER-SENSITIVE test instrument costs you only \$6 more than the regular "22" tube tester. Meter is 3 1/2" D'Arsonval type with 2% accu-racy. See complete description of Model 22. Model 23 Combination Dealer's and Service- men's Net Price..... \$29.75

## Model 24-B TUBE TESTER AND ANALYZER



A moderate priced testing laboratory. A Modern 22 Tube Tester an up-to-date 1000 Ohm Volt-Ohm-Milliammeter and Output meter. Consists of the 22 tube tester, and Volt-Ohm-Mil unit in one case. A.C. and D.C. voltage range 0-15, 0-150, 0-300, 0-600. Mil range 0-15, 0-150. A LOW OHM read-ing up to 500 ohms, high ohm 500,000. All ranges IN-STANTLY AVAILABLE by rotation of selector switch. No "juggling" with pin jacks. Test prods included. A FIVE RANGE TESTER Voltmeter-Milliammeter-Ohm-meter-Output Meter & Tube Tester, Port-able quartered oak case 10" by 17", wt. 16 lbs. \$34.90  
Dealer's and Servicemen's Net Price.....

## Model 14 L & L TUBE TESTER



A POINT-TO-POINT TUBE TEST-ER. Allows regular tube test or step by step analysis of ALL TUBE ELE-MENTS.

TESTS ALL TYPES OF TUBES whether glass or metal. GOOD-DOUBT PUL-HEAD English read-ing meter. D'Arsonval 2% Accuracy. LEAKAGE indicated directly on meter SHORTS on pilot. Full line volt-age control by means of tapped trans-former and panel switch. EMBRACES all features desired with full POINT-TO-POINT test provisions which permit any future type to be traced REGARD-LESS OF LOCATION OF TUBE TERMINALS.

Comes complete with chart for all present day tubes. Veri-Chrome lettered bakelite panel. Black hardwood case. Wt. 8 lbs. This tester will save you MANY DOLLARS IN COST. COMPLETE as described..... \$13.90  
Mounted in Portable case..... \$15.90

Send for circulars of other testing equipment

**L & L ELECTRIC CO.**  
362 Madison Ave. Memphis, Tenn.

## TELEVISION AND ULTRA-SHORT WAVES

(Continued from page 398)

difference between an artist who assembles a mosaic picture, and a television engineer who attempts to reproduce a high-definition image.

### HIGH-DEFINITION IMAGE REQUIREMENTS

While the mosaic artist has plenty of time to complete his picture—which consists of perhaps 40,000 stained squares—, the television engineer who has to reproduce television images full of life and with all movements must assemble his 40,000 picture elements within 1/25-second (in order to avoid flickering)! In other words, he has to transmit and assemble in each second 1,000,000 picture elements!

Electrically, it means that the photoelectric cell used in the television station for such 40,000 picture element transmission furnishes the transmitter with a "sideband modulation" going from zero to about 500,000 cycles, or 500 kc.

But sidebands of 500 kc. are only the minimum limits of modern television image transmission! Experiments in Europe have indicated that a television transmission consisting of 40,000 picture elements does not produce the same entertain-ment value as a good home movie projection. The next step, now being taken in European television broadcasting, is the "76,000 picture element transmission," which is equal to a 240-line transmission, and a sideband frequency of about 1,000,000 cycles or 1,000 kc. (see Table I).

Table I

Scanning Lines	Picture Elements	Sideband Frequency
60	4,798	63,970
120	19,200	256,000
180	43,190	576,000
240	76,780	1,024,000
360	172,800	2,302,000
480	307,100	4,094,000

### LIMITATIONS IMPOSED BY THE WIDE SIDEBAND

What a sideband modulation of 1,000 kc. actually involves can be seen from the following facts.

It is well known that there are certain limita-tions in the modulation of a transmitter. The laws of modulation require that "the carrier frequency must be higher than (or at least equal to) the highest modulation frequency." The longest wavelength which could be modulated with a picture element frequency of 1,000 kc. is theoretically the wavelength of 300 meters, which has a carrier frequency of 1,000 kc.

Even in case this wavelength was chosen, the sideband spread of the transmitter would cover not only the entire broadcast range, and the entire long-wave band, but also the short-wave

Output stage of the 16 kw. ultra-short-wave tele-vision transmitter in Berlin which operates on a wavelength of 6,925 meters. This amplifier uses two 20 kw. tubes.

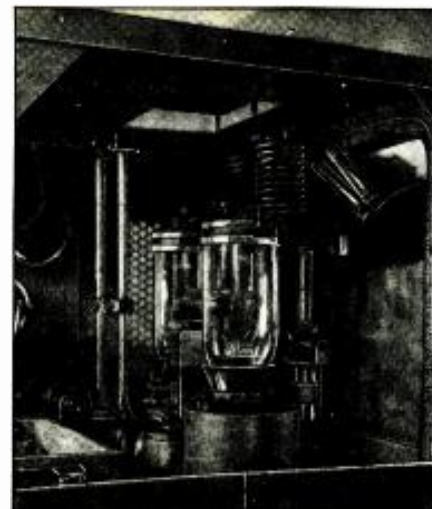

band down to 150 meters, as Fig. 1 shows. For this pleasure of operating one single television transmitter on a wavelength of 300 meters all transmissions in the wave ranges over 150 meters, up to the longest waves of 30,000 meters length, would be disturbed. As Fig. 1 shows, high-definition image transmissions on the normal broadcast band are entirely out of the question. But even in the ordinary short-wave range between 10 and 200 meters, such a trans-mitter cannot be operated, because this band is crowded with broadcast and commercial trans-missions. The only wavelengths on which high-definition image transmissions can be carried out are the ultra-short waves between 1 and 10 meters.

### VISUALIZING ULTRA-SHORT-WAVE BAND WIDTH

At present only the wavelengths between 5 and 9 meters are used for television but later, the shorter waves down to 1 meter may be utilized for television transmission. At first glance, the wave range between 5 and 9 meters seems pretty small. But actually it is as broad as the entire short-wave, broadcast-wave, and long-wave ranges together!—A wavelength of 30,000 meters (which is the longest wavelength used) corresponds to a frequency only of 10 kc. The wavelength of 10 meters corresponds to a fre-quency of 30,000 kc. We have also in the entire range between 10 and 30,000 meters a frequency range of about 30,000 kc. available.

Since the corresponding frequency of a wave-length of 5 meters is 60,000 kc., the wave range between 5 and 10 meters provides us with a frequency range of 30,000 kc. This is as much as the entire wave range above 10 meters. This readily shows us that the small wave range be-tween 5 and 10 meters has tremendous frequency dimensions. In this wave range about 3,000 different broadcast transmitters could be oper-ated on the usual 10 kc. allotment, or 15 tele-vision transmitters with a 2,000 kc. allotment, which is by far more than one might expect.

### HOW MANY ULTRA-SHORT-WAVE TELEVISION PROGRAM TRANSMITTERS DO WE NEED?

But 15 television stations are not too many as the following lines will show. According to a report read by Dr. Baker, vice-president of RCA, during the famous Spring Meeting of the Institute of Radio Engineers, in Philadelphia, May 1934, the United States alone needs 80 television transmitters if all parts of the coun-try are to be sufficiently covered with television impulses.

Despite the fact that there are still plenty of television channels available in the wave range between 1 and 5 meters, (this range involves an additional frequency band of 240,000 kc., which is sufficient for 120 television transmit-ters) another interesting factor comes up. Ultra-short waves are quite different in their propagation from the ordinary short waves. They do not seem to be reflected by the Heavi-side layer, and do not bend around the globe. (That, at least, with a few exceptions, is the present conception.)

### IMPORTANCE OF A HIGH ANTENNA

That means in simple language that reception is generally confined to within a distance of perhaps 50 to 100 per cent greater than the actual optical sight range (see the heading illus-tration).

That is the main reason why ultra-short-wave transmitters have been installed atop tall build-ings, etc. The experimental television trans-mitter of RCA and NBC has been installed on the tower of the Empire State Building (N.Y.C.). London's television transmitter has its antennas high up on the tower of the Crystal Palace. The new television transmitter of the French Post Office will be installed on the radio tower of the new Paris broadcasting station, "Paris P.T.T.," at Villejuiste (a suburb of Paris). And finally, the oldest European tele-vision station, "Berlin," operates with antennas fixed atop the old Berlin radio tower 453 ft. above the ground (see Fig. A). This trans-mitter has been regularly received at the Brocken mountain, in the middle of Germany, which has a height of about 3,700 ft., and is located, by airline, 125 miles west of the Berlin television transmitter.

Please Say That You Saw It in RADIO-CRAFT

Despite the fact that the Berlin transmitter is received about 25 miles "behind the optical horizon" and about 3,000 ft. "below the horizon," on Brocken mountain, fairly good reception of the Berlin television programs is obtained.

These examples show that it is much too early to state the actual limitations of ultra-short-wave reception, and until we know better it might be advisable to abide by the usual definition of these very short waves as "quasi-optical"!

**SUITABLE RECEIVING CIRCUITS**

While the super-regenerative receiver has a dominating place among circuits for the reception of sound broadcast or code signals on ultra-short waves, it is not the best circuit for the pick-up of television image impulses because of its background noise, which has a distorting influence upon the image reproduction.

The straight T.R.F. circuit, again, has not enough gain per stage in this frequency range, and too many stages would be necessary to obtain the needed amplification. Therefore, the superheterodyne circuit remains as the only one which at present fills the circuit requirements of a television receiver. As an input and mixer stage for a "super," the good old-fashioned "autodyne" circuit has again been taken out of the attic, and is generally used in Europe in this position for television receivers. The skeleton diagram of such an autodyne circuit is shown in Fig. 3.

This circuit is detuned from the input signal by a certain percentage, depending on the width of the chosen intermediate frequency. The resulting I.F. is picked up by means of specially-designed I.F. input transformers with a special, broad-response curve of about 1,000 kc.

But as Fig. 3 indicates, the first I.F. transformer has two secondary windings; one connects (as the figure indicates, via a tube and leads) to the "image I.F. amplifier" system; the other secondary winding connects with the "sound I.F. amplifier" system. At first glance this design seems strange. But if we keep in mind that it is the custom in Europe to radiate sound and image impulses by 2 different ultra-short waves which are kept on 2 certain wavelengths with a constant frequency difference, the solution of the problem is easy. The self-generating local oscillator beats with the signal frequency to produce one intermediate frequency impulse, and at the same time the oscillator beats with the carrier frequency of the sound impulses, producing another intermediate frequency. Each of these groups of impulses is filtered out in the first I.F. transformer, and then sent through separate I.F. amplifier systems.

Since the frequency difference between both transmitters is always kept constant, the tuning of such a television receiver is quite simple. In order to obtain the best image reproduction, the oscillator is tuned for best sound reproduction and automatically the best image reproduction is obtained. How such a modern television receiver operates is shown in the simplified diagram, Fig. B, which represents the circuit sequence in a Telefunken (Berlin, Germany) television receiver.

**A SIMPLE 2-TUBE A.C. SHORT-WAVE CONVERTER**

(Continued from page 404)

parts and special low-loss coils. It covers practically the entire radiophone spectrum from 19 to 200 meters. It is completely self-powered. It is easily connected to any receiver and need not be disconnected to receive ordinary broadcasts. The band-selector switch automatically turns off the A.C. supply to the converter as well as switching the antenna back to the receiver.

"How can these short-wave stations be received on a 'radio' not designed to tune them, without rewiring?"

A superheterodyne short-wave converter consists essentially of a short-wave tuning system and a tuned local oscillator or signal generator. The antenna signal is selected and amplified by the tuning system. The local oscillator generates a signal somewhat lower in frequency which is made to beat with the incoming signal resulting in a modulated beat signal equal to the difference between these frequencies. The tuning circuits of the converter are so designed that this difference will be in the broadcast band and hence tunable on any radio receiver.

**A 5-TUBE A.C.-D.C. "TURRET" ALL-WAVE SET**

(Continued from page 401)

ing it with the broadcast coil. Rotate the switch arrangement until the broadcast coil is in the correct functioning position. In many locations, this set will bring in local broadcasting without using an aerial as the receiver is very sensitive. If objectionable hum is noticed on A.C. it may be necessary to increase the values of filtering condensers C15 and C16. The small condenser at C17 is for the purpose of getting rid of tuneable hum.

This receiver makes a very desirable all-wave set for general home use.

**LIST OF PARTS**

- One Hammarlund antenna trimmer, 10 to 70 (in diagram, 2 to 35) mmf., type MICS-70. C1;
- One Cornell-Dubilier cartridge condenser, .1-mf., C2;
- One Cornell-Dubilier cartridge condenser, .1-mf., C3;
- One Hammarlund trimmer, type MICS-140. C4;
- One Hammarlund variable condenser, type MC-140-M. C5;
- One Hammarlund variable condenser, type MC-50-5 (optional). C6;
- One Cornell-Dubilier cartridge condenser, .1-mf., C7;
- One Cornell-Dubilier mica condenser, 500 mmf., C8;
- One Cornell-Dubilier cartridge condenser, .01-mf., C9;
- One Cornell-Dubilier cartridge condenser, .1-mf., C10;
- One Cornell-Dubilier cartridge condenser, .1-mf., C11;
- One Cornell-Dubilier cartridge condenser, .01-mf., C12;
- One Cornell-Dubilier cartridge condenser, 5 mf., 35 V., C13;
- One Cornell-Dubilier mica condenser, .006-mf., C14;
- One Cornell-Dubilier dual-section cardboard electrolytic condenser, 16 mf. each section. C15, C16;
- One Cornell-Dubilier cartridge condenser, .01-mf., C17;
- One I.R.C. metallized resistor, 10,000 ohms, 1 W., R1;
- One I.R.C. metallized resistor, 600 ohms, 1/2-W., R2;
- One I.R.C. metallized resistor, 25,000 ohms, 1/4-W., R3;
- One I.R.C. metallized resistor, 1 meg., 1/2-W., R4;
- One I.R.C. metallized resistor, .175-meg., 1 W., R5;
- One Electrad potentiometer with switch Sw.1. 75,000 ohms. R6;
- One I.R.C. metallized resistor, 25,000 ohms, 1/4-W., R7;
- One I.R.C. metallized resistor, 1 meg., 1/2-W., R8;
- One I.R.C. metallized resistor, 1 meg., 1/2-W., R9;
- One I.R.C. metallized resistor, 10,000 ohms, 1 W., R10;
- One I.R.C. metallized resistor, .175-meg., 1 W., R11;
- One I.R.C. metallized resistor, 1 meg., 1/2-W., R12;
- One I.R.C. metallized resistor, 600 ohms, 1 W., R13;
- One Blan 180-ohm, 50-W. resistor in line cord. R14;
- One Hammarlund midget R.F. choke, type CH-X, 2 1/2 mhy., R.F.C.;
- One A.F. choke, 300 ohms, 20 hy., Ch.;
- Two Na-Ald twin phone-tip jacks, J1, J2;
- One set of 5 Hammarlund plug-in coils covering band from 17 to 560 meters. T1;
- One RCA Radiotron 6C6 tube, V1;
- One RCA Radiotron 6J7 metal tube, V2;
- One RCA Radiotron 6C6 tube, V3;
- One RCA Radiotron 43 tube, V4;
- One RCA Radiotron 25Z5 tube, V5;
- One Wright DeCoster 5-in. dynamic speaker for type 43 tube output, speaker field 3,000 ohms;
- One Na-Ald universal coil selector unit;
- Three Na-Ald screen-grid clips;
- One Blan metal chassis 11 x 6 x 2 ins.;
- One Na-Ald 4-prong socket for coil;
- One Na-Ald octal socket for 6J7 tube;
- Four Na-Ald 6-prong sockets for V1, V3, V4 and V5;
- Knobs, hardware, dial.

**"YOUR NEW BOOK IS THE REAL McCOY!"**



**SEND FOR YOUR FREE COPY TODAY**

● Service men all over the country tell us that the new volume of SERVICE HINTS can't be beat . . . send for your FREE COPY today! Yes, Sir! Sylvania's new volume of Service Hints is the real thing! It's got the right answers for the tough problems you're always running up against in a day's work. And what's more, this book was written by crack service men themselves . . . contains actual problems and solutions from men who are on the job . . . who know radio! Don't wait! Send for your FREE COPY of SERVICE HINTS today. Find out how the information in this book will simplify your hard-to-crack jobs. Put yourself in a position for more and better service jobs at bigger profits. Right now . . . fill out this coupon and send it to the Hygrade Sylvania Corporation. The new volume of Service Hints will be sent you absolutely without charge.

Hygrade Sylvania Corporation, Makers of Sylvania Radio Tubes and Hygrade Lamps. Factories at Emporium, Pa., Salem Mass., and St. Mary's, Pa.

**SYLVANIA**

THE SET-TESTED RADIO TUBE  
© Hygrade Sylvania Corp., 1935

Hygrade Sylvania Corporation, Emporium, Pa.	RC-1
Please send me free, without obligation, Volume 2 of Sylvania's "Service Hints."	
Expertment <input type="checkbox"/> Amateur <input type="checkbox"/> Call <input type="checkbox"/>	Employed by dealer <input type="checkbox"/>
Service man <input type="checkbox"/>	Independent <input type="checkbox"/>
Member Service Organization.....	
NAME .....	
ADDRESS .....	
CITY..... STATE.....	
NAME OF JOBBER.....	
ADDRESS.....	

Please Say That You Saw It in RADIO-CRAFT



**WANTED**—Fully experienced Radio Service Expert. "Screw driver mechanics" need not apply. Must be fast, accurate and thoroughly familiar with all types of modern radio work. A real opportunity for the right man. State qualifications in detail. Box 101, c/o Bulletin.

# Could You Fill This Service Job?

Under improved business conditions, dozens of good-paying opportunities will soon be popping up in radio. Your future depends on whether or not you are qualified to grasp them. Will they go to other fellows—or will you MAKE them come to you!

Sprayberry Training is designed NOT for beginners but for men already in the service business who recognize the need for keeping up-to-date. It is for men who know that, to get better-than-average jobs, they have to be better-than-average workmen. It is sound, practical business and technical training—at a price within the reach of all. Investigate!

**"IS YOUR FUTURE IN SERVICING WORTH \$20?"**



**F. L. SPRAYBERRY**, 2548 University Pl., N. W., Washington, D. C.

Without obligation, send me details on your advanced Service training.

Name.....  
 Street.....  
 City..... RCI-36

**SPRAYBERRY'S PRACTICAL MECHANICS OF RADIO SERVICE**

## TUBE PRICES REDUCED!

ARCO Tubes—Guaranteed 6 Months—Licensed by R. C. A.—All prices F. O. B. factory, Newark, N. J. Orders for less than \$3.00 not accepted. 50% deposit required on all orders.

REGULAR TUBES											
Your Cost	Your Cost	Your Cost	Your Cost	Your Cost	Your Cost	Your Cost	Your Cost	Your Cost	Your Cost	Your Cost	Your Cost
.26c	.31c	.40c	.44c	.56c	.68c	.90c	.90c	.90c	.90c	\$1.13	
Type 01A	Type 12A	Type 24A	Type 19	Type 00A	Type 83V	Type 10	Type 48	Type 26	Type 27	Type 35-51	Type 20
26	30	36	33	22	6F7	12A5	2B6	37	31	38	42
37	39	39	43	34	P2H	12A7	586	40	41	46	53
45	44	49	59	59	484			56	47	55	79
71A	57	75	84	58	75S			76	58	77	84
	82	78	WD11	83	85	WD12			5Z3	89	1A6
	6D6	99V	2A3	99X	2A7				2A5	2B7	
		2A6	6A4(1a)	2A6	6A4				6C6	6A6	
		12Z3	6A7	25Z5	6B7				6Z4(184)		

MAJESTIC TYPE TUBES					
Your Cost	Your Cost	Your Cost	Your Cost	Your Cost	Your Cost
\$1.04	\$0.75	\$0.79	\$0.79	\$0.77	\$0.77
Type 2A7S	Type 6D7	Type 55S	Type 27S	Type 36	Type 28YS
1.04	6E7	.86	35S-51S	.63	28-4S
1.19	6F7S	.86	56S	.59	2Z2-C84
.83	6Y5	.59	57S	.79	6A7S
1.04	6Z4	.86	58S	.77	6B7S
.95	6Z5	.59	75S	.77	6C7
.86	25-25S	1.22	85S		

Quotations on Transmitting Tubes, Television Tubes, Charger Bulbs, Photo Cells, Croter Tubes, Cathode Ray Tubes, sent upon request.

**ARCO TUBE CO.** 227 CENTRAL AVENUE NEWARK, NEW JERSEY

**Reduce Noise On ALL Waves**

**LYNCH MI-FI ASSEMBLED ALL-WAVE ANTENNA** Write for folder

**LYNCH FILTERADIO** Cuts out objectionable noise from the light line. Easy to install; simple to adjust. \$5.00 List

All ready to hang. Saves 90% of installation time. Amazing results. \$6.75 List

Arthur M. Lynch, Inc., 227 Fulton St., N. Y. PIONEER OF NOISE-REDUCING AERIALS

## OPERATING NOTES

(Continued from page 402)

traced to loose laminations in the filter choke coil.

**Sterling G.** The power transformer in a Sterling Model G would start to smoke after a few minutes, and the fuse would blow. The primary of the transformer was found to be shorted, and was replaced.

**A.C. Dayton Navigator.** A defective A.C. switch was the cause of no reception on an A.C. Dayton Navigator.

**Midwest 16-Tube.** A sparking 82 tube in this all-wave receiver was caused by two shorted 8 mf. filter condensers.

**Stromberg-Carlson 14A.** An intermittently shorting filter condenser was the cause of the the two 80 tubes sparking, in a Stromberg-Carlson model 14A, illustrated in Fig. 1F.

**Earl 31.** Set complaint was, "no signals." I finally traced this to no voltage on the detector plate. The plate supply resistor was replaced, curing the trouble. The circuit is shown in Fig. 1G.

WILHO G. MYILYKANGAS

## HAMMARLUND COMET PRO

**MANY MODELS** of the Hammarlund Comet Pro are equipped with a 47 pentode in the output stage; later models were made with a 2A5 in place of the 47, the result being a fair increase in volume. One of my clients requested that I make this change for him, and this was done as shown at A in Fig. 2; the old connections being shown at B.

W. I. BONKIN, Cristobal, C.Z.

## RADIOLA 80

**RECEPTION** on this set was very poor, changing from strong to weak signals with considerable distortion. After considerable trouble we located an open circuit in the primary of the push-pull input transformer. The primary of his transformer has a D.C. resistance of 2,000 ohms and the secondary, 13,000 ohms, center-tapped. We made a temporary repair with an ordinary A.F. transformer of the 3-to-1 variety and center-tapped the secondary by using two 7,500-ohm resistors connected from grid-to-grid prongs, with the center-tap connecting to the bias lead.

## GENERAL MOTORS "LITTLE GENERAL"

**IF YOU** want to avoid trouble with call-backs on these sets it is a good idea to replace the whole voltage divider system. "One watters" can be used for all except the 6,000-ohm section where it is safer to use units of 8 to 5 W. rating, since this section furnishes plate and screen-grid voltages to the R.F. tubes.

## GRAYBAR 100

**POOR,** or no reception conditions in this set model, with the type 27 A.V.C. tube in the socket, and good reception with it removed, have been traced to the cathode bypass condenser. The heater and cathode of the A.V.C. tube are tied together and bypassed to the grid. We used a 0.5-mf. condenser which worked very nicely.

## CANDOHM RESISTORS

**MANY** of the newer sets are using these resistors for voltage dividers. If you find one section bad it is safe to replace the whole thing rather than just one section. At least it will save you call-backs. Replace with a good vitreous enameled wire-wound resistor that can "take it."

## ATWATER KENT 55 AND 55-C

**THESE** sets show considerable regularity in the failure of the bias resistors, resulting in poor tone and fading.

C. BRITTON

## PHILCO 76

**A BURNED-out** primary in the first A.F. transformer was the original trouble here. After replacement, the set worked fine in the shop but when installed in the cabinet, it

wouldn't play. A test showed no plate voltage on the type 45 tubes. I took the set back to the shop, turned it on and everything was OK! After a lot of probing around, I happened to pick up the speaker and turn it around and—out goes the broken.

Investigation showed a broken wire under the output transformer, which is located on the speaker. The fault would show only when the speaker was turned so that the transformer was standing upright.

JAMES J. WALTERS

## MAJESTIC M-25

**AT LOW** volume, the tone of this set is often poor, but at high volume the condition corrects itself. This model uses two 27 tubes in a balanced circuit as second-detector. Replacing both these tubes will remedy the trouble.

**IN MANY** large radio sets using two pentode power tubes, the 80 rectifier is short lived because of the heavy drain. In these cases I replace it with a 5Z3. The power transformer is easily able to supply the extra 1.A. of filament current necessary for the larger tube, and no more trouble is experienced from this source.

## WESTINGHOUSE 801

**A WESTINGHOUSE 801** (Columnaire) receiver was troubled with bad tone, especially bad at low volume. After a careful test of all voltages the cathode voltage on the second-detector was slightly high. This suggested the measurement of the plate current of this tube, which, with no signal, was zero. The cathode resistor was then replaced with one of a lower resistance, although not without some misgivings, as the other resistor, when tested, showed the proper resistance. The set then worked beautifully for half an hour and then exactly the same trouble appeared again. The trouble was eventually traced to a leak between the screen-grid and detector bias bypass sections of the bypass condenser block, causing an abnormal amount of current to be bled through the bias resistor and causing sufficient voltage drop across it to badly over-bias the detector.

## PHILCO 20

**THIS** is an old 7-tube set using 3-34s, 1-27, 2-71As, and 1-80. The push-pull input transformer gives trouble; the primary and often the secondary too, opens up, due to corrosion caused by moisture entering the windings. A Jefferson No. 467-402 transformer fits the chassis exactly and makes a perfect, inexpensive replacement.

W. WELSH

## A UNIVERSAL-CURRENT I-TUBE ALL-WAVE PORTABLE

(Continued from page 404)

been fastened permanently to the car. Plug A then goes in socket A which completes the circuit. The filament transformer is an ordinary small bell-ringing transformer.

The pentode section of the 6F7 is used as the amplifier in this particular circuit, while the triode is the regenerative detector.

### LIST OF PARTS

- One set Hammarlund 4-prong plug-in coils;
- One Hammarlund air padding condenser, 100 mmf., C2;
- One Hammarlund variable condenser, 140 mmf., C3;
- One Aerovox mica condenser, 150 mmf., C1;
- One Aerovox mica condenser, 100 mmf., C6;
- One Aerovox paper condenser, .25-mf., C4;
- One Aerovox mica condenser, .001-mf., C5;
- One Aerovox mica condenser, .002-mf., C7;
- One Electrad variable resistor, R1, 0.1-meg., with switch, Sw.1;
- One I.R.C. carbon resistor, 1/2-W., 1.5 megs., R2;
- One Eby 4-prong bakelite socket;
- One Eby 7-prong bakelite socket;
- One Eby 4-prong wafer socket, C;
- One ordinary 2-prong outlet socket, A;
- One General Transformer Corp. 3-to-1 A.F. transformer, T1;
- One Blau small bell-ringing transformer, T2;
- One pilot light with switch, Sw.2;
- One metal tool case;
- Wire, binding posts, etc.

## CHOOSING THE I.F. FOR ALL-WAVE SUPERHETS.

(Continued from page 403)

signal (1,000 kc.) by 350/1,000 x 100 or 35 per cent of the desired signal frequency. This condition is shown at Fig. 2A. If a higher I.F. (say 465 kc.) were employed in the receiver, the new "image" interfering signal (1,930 kc.) would differ from the desired signal (1,000 kc.) by 930/1,000 x 100, or by 93 per cent of the desired signal frequency. This is shown at Fig. 2B. The advantage of using the higher I.F. is apparent, for it is much easier for the tuned circuits of the receiver to eliminate the image interfering signal if its frequency differs from that of the wanted signal by 93 per cent than it is if the frequency difference is only 35 per cent.

### SHORT-WAVE SELECTIVITY

Now let us consider the effect of a high I.F. when short-wave signals are being received. Consider the case for the reception of a 15,000 kc. signal. If the same low I.F. (175 kc.) were used, and the receiver were tuned to this 15,000 kc. signal, the frequency of the image interfering signal would differ from that of the desired signal by 350/15,000 x 100, or by only 2.33 per cent of the desired signal frequency. This condition is illustrated in Fig. 2C. Hence, it would be difficult to eliminate interference from it. If a higher I.F. of say, 465 kc. is employed instead, the frequency of the "image interfering" signal differs from that of the desired signal by 930/15,000 x 100, or by 6.2 per cent of the desired signal frequency. (See Fig. 2D.)

These simple calculations are sufficient to show that the I.F. which is employed in an all-wave receiver is very intimately tied up with the image interference problem. If a single I.F. is used for both short-wave and standard broadcast-band reception (as is the case in most medium-priced receivers), some compromise must be effected. The image interference problem dictates that a very high I.F. be used for its solution. However, it is not advisable to employ a very high I.F. for standard broadcast-band reception because the I.F. used will then fall within the standard broadcast-band range of frequencies and interference will result. For these, and other pertinent reasons which lack of space prevents us from explaining, the compromise intermediate frequencies which are being used in all-wave receivers today, lie within the region between about 456 and 472.5 kc. (See Fig. 1). Their choice, therefore, is based entirely on these sound engineering principles and the experience gained through the interference problems which have come up in various localities with previous models.

## FOR BEGINNERS—A "4-IN-2" A.C.-D.C. SHORT-WAVE-SET

(Continued from page 405)

- One Standard Transformer Co. small 400-ohm A.C.-D.C. filter choke, Ch.;
- One Hammarlund 6-prong isolantite socket for coil, type S-6;
- Two Hammarlund 7-prong isolantite sockets, type S-7-B;
- One Hammarlund kit of 6-prong plug-in coils, type SWK-6, L;
- One Eby antenna-ground binding post;
- One Eby speaker binding post;
- One Blau 7 x 10 in. aluminum panel;
- One 10 x 11 in. wooden baseboard.

### Modernization Service

Zeh Bouck's new book, "8,000,000 Jobs for the Service Man," forms the nucleus of a complete merchandising plan for receiver modernization which also includes stickers, mats for local advertising, descriptive sales literature for prospects, window cards, etc. Mr. Bouck's book contains detailed information on the changes necessary to convert representative broadcast receivers into modern all-wave jobs. Photographs, circuits, diagrams, methods of getting business and suggested charges are also included.

A complete set of this material, including Mr. Bouck's book, enabling the Service Man to get started immediately in this profitable business can be obtained for 25c from the Tobe Deutschmann Corporation, Canton, Mass.

## ALIGNING ALL-WAVE RECEIVERS

(Continued from page 403)

trimmers in the I.F. transformer should be adjusted until a signal is heard, or is indicated on the output meter. The trimmers should then be adjusted for peak output indication starting from the first-detector I.F. transformer and working back to the second-detector. As higher and higher peak indications are obtained on the output meter the oscillator attenuator should be turned down, while still keeping the output meter "on scale." Do not make this adjustment by turning down the receiver volume control. If the receiver is equipped with automatic volume control, it is best to eliminate this action by removing the A.V.C. tube. If this cannot be done without stopping the functioning of the receiver, the A.V.C. lead connecting to the return grid circuits of the I.F. tubes should be grounded to the chassis. If neither of these arrangements is convenient, alignment should be made below the voltage level where the A.V.C. operates. This can be done by turning the attenuator down to a very low value and working at this point.

### R.F. ADJUSTMENT

Connect the service (test) oscillator to the antenna and ground posts of the receiver and remove the shorting clip on the receiver oscillator gang section. If possible the A.V.C. action should be stopped as mentioned above under I.F. alignment. Turn the receiver to the broadcast band and set the oscillator tuning control at 1,400 kc. Turn on the oscillator and tune in the signal on the receiver. Adjust the shunt padders on the oscillator and first-detector circuits (also, the R.F. section if there is one) in the order mentioned. If there are trimmers for each band available, make sure that the ones adjusted are those for the broadcast band. The shunt trimmers can be differentiated from series padders by noting the number of foil sections, shunt padders having only one pad while the series padders have several, the capacity being somewhere around 800 mmf.

Turning the oscillator tuning control to the 600 kc. point, again tune in the signal. Most all-wave sets manufactured today are equipped with an oscillator series padder indicated for reference in Fig. 1. Having tuned in the signal, while obtaining a reading on the output meter adjust the series padder for maximum reading. As the oscillator frequency practically determines the whole tuning of the receiver this adjustment should be made very carefully. To make sure that it is correctly aligned the receiver dial should be moved either to the right or to the left approximately 5 kc. The oscillator series padder should again be adjusted and a notation made as to whether the reading was higher on the output meter than before. If this is found to be the case, the receiver dial should be moved another 3 or 4 kc. and a third adjustment made. If it is found that lower readings are being obtained the dial should be turned in the reverse direction and the same procedure gone through.

The better grades of all-wave receivers are equipped with a bank of trimmers, one set being used for each short-wave band. The diagram of the receiver should be examined to make sure that these trimmers are switched into the circuit.

Turn the receiver to the first short-wave band and tune the oscillator to a frequency indicated by the receiver dial as being approximately 10 per cent of the highest frequency for that particular range. Locate the shunt trimmer for this band by touching a screwdriver to each of the trimmer condensers and notice which one causes a change in signal intensity indicating that it is in the R.F. circuit. Make sure that this is the shunt trimmer for the band as indicated by the very small capacity of the unit. Having tuned in the oscillator signal correctly adjust this trimmer for a maximum indication on the output meter. Examine the other trimmers and note whether or not there is a series padder for this band. If there is, tune the receiver and oscillator to a point 10 per cent up from the lowest frequency for the band and make the same type of adjustment as covered by the directions given for aligning the low-frequency end of the broadcast band.

Switch the receiver to the next short-wave band and proceed in the same manner, adjusting the shunt padder near the high-frequency end of the band, and the series padder near the low-frequency end.

# C-B Equipment for all Cathode-Ray Applications



### Beat-Note Audio Oscillator

**MODEL 79**—A necessary companion to the Cathode-ray Oscillograph now offered at a new low price. Continuously variable 50 to 10,000 cycles. High voltage output at 5,000-ohm load. Pure sine wave. Low distortion content. Constant output voltage. Zero-beat indicator and adjustment. Operates from 110-volt 60-cycle. Net price, complete with six tubes...\$51.90

### Frequency Modulated Oscillator

**MODEL OM**—All-wave continuously variable from 85 kc. to 30 mc. Built-in fixed-sweep frequency modulator provides calibrated selectivity curve images with any standard oscilloscope. May be used as standard oscillator if desired. 1/2 of 1% frequency accuracy on direct-reading chart or hand-drawn 11" x 17" calibration curves. Net, complete with tubes...\$57.75

### Cathode-Ray Oscilloscope

**MODEL CRA**—Cathode-ray Oscilloscope with built-in amplifier and power supply. Highest input sensitivity of any standard design. Portable for field or laboratory use. New simplified controls. Write for new booklet "Cathode-Ray Test and Analysis" outlining application procedure of this instrument to service, broadcasting, and industrial fields. Complete with 3" Cathode-ray and all other tubes, net \$84.50

Get this new book!

Cathode-Ray Test and Analysis  
25c in stamps



The CLOUGH-BREngle Co.  
1130 W. Austin Ave., Chicago, U. S. A.

Send full description of the complete CLOUGH-BREngle line of precision instruments (without cost). Enclosed find 25c in stamps for copy of Kendall Clough's new booklet, "Cathode-Ray Test and Analysis."

Name \_\_\_\_\_  
Address \_\_\_\_\_

Please Say That You Saw It in RADIO-CRAFT



## Take The Set DESIGNER'S WORD For It!



**D**ONALD LEWIS has developed the Beginners' 2-tube AC-DC Short and All-Wave Set and it's a wow!

When you build it, use the Hammarlund condenser, illustrated above, and the five other Hammarlund precision parts Mr. Lewis specifies.

If you want results, DON'T SUBSTITUTE. The designer knows what makes his set percolate. Take his word for it and be sure!

- (1)—Write for FREE NEW CATALOG of Condensers, Transformers, Chokes, Sockets and general equipment for receiving and transmitting.  
(2)—SEND 10c for New 32-page Manual of most popular Short-Wave Receivers, with illustrations, diagrams and parts lists.

Address Dept. RC-1

HAMMARLUND MANUFACTURING CO.  
424-438 W. 33rd St., New York



**CORNELL DUBILIER**

**OIL MICA PAPER ELECTROLYTIC**

The finest guaranteed condensers money can buy.

Write for descriptive catalog No. 128.

**CORNELL DUBILIER CORPORATION**  
4347 BRONX BOULEVARD  
NEW YORK

**Brush Type A 'Phones**

meet every headphone requirement. Response 60 to 10,000 cycles. Brush phones operate from any normal source . . . give greater volume from weak signals. No magnets to cause diaphragm chatter. Will handle excessive volume without overloading. Specially designed cases minimize breakage. Weight . . . 6 ounces. Now available at the new low price . . . only \$3.00 list. Data Sheet No. 10 gives full headphone information and circuit diagrams. Free on request. Send for your copy today.

**BRUSH** DEVELOPMENT COMPANY  
CLEVELAND O.

288B.40:5C  
MICROPHONES • MAKE STANDS • TWISTERS • HEAD PHONES • LOUD SPEAKERS

## HOW TO MAKE A FLOATING-GRID RELAY

(Continued from page 407)

36, 58, etc. Various circuit arrangements were tried, the most favorable being shown in Fig. 2. The voltages required for maximum sensitivity are fairly critical.

A metal plate 1 in. square was soldered to the grid-cap to increase the effective sensitivity of the tube to outside capacity. (See Fig. A.)

In experimenting with various hookups it was found that the sensitivity of the tube was considerably reduced if the cathode of the tube was grounded. For this reason the hookup shown in Fig. 2A cannot be expected to have a high degree of sensitivity. In this hookup it would be necessary to use a low-resistance type of sensitive relay in the plate circuit if the tube is to function at its best, as a total of 85 V. is required at the plate, leaving only a 15 V. drop for the relay. By using "B" batteries, or a step-up transformer as shown in Fig. 2B, these difficulties may be overcome. Because of the pulsating rectified current in the plate circuit it is necessary to use a relay of the proper type for this purpose. However, by the addition of a rectifying tube and filter supplying a pure direct current, a conventional magnetic relay may be used. Such a circuit is shown in Fig. 2C, and is the one around which the model pictured in Fig. A was constructed.

A relay of the type used in "A" and "B" eliminators was rewound to a resistance of 5,000 ohms, and somewhat re-vamped for this use. (Some mechanical relays will require a condenser across the coil because of a small A.C. component which exists as the relay throws-off at minimum current.) Where great sensitivity is desired, a meter type of relay (see *Radio-Craft*, December 1935, page 346) should be used, and is preferred when speed is essential.

### HOW TO SECURE REVERSE ACTION

If a reverse action of the operating current is desired it may be produced with the arrangement shown in Fig. 3. Here it is possible to obtain only a slight gain in amplification unless the capacity moves with speed as it approaches or leaves the tube's control-grid, due to the dynamic plate-resistance of the tube. This action may be noticed if the hand slowly approaches the tube (until a reading of about 4 ma. is obtained), then suddenly withdrawn. The current will drop to zero before returning to the normal maximum. A slow removal of the hand would cause the current to rise slowly to its former level. (In this experiment the magnetic relay should be shorted out as it acts as a choke to sudden changes.)

If the hand or some other conductive object comes in contact with the control-grid the current drops to zero and some time elapses before it returns to normal. With the model shown in Fig. A this time amounted to about 3 seconds, varying somewhat with different-size plates on the grid-cap. This action seems to offer possibilities in connection with time-delay relay systems.

### USES OF THE RELAY SYSTEM

Construction costs of this relay permit it to be used in various instances to replace oscillating-circuit relays and grid-glow tube relays.

The uses to which the relay may be put are limited only by the ingenuity of the experimenter. A few uses are: Counting objects passing on a conveyor belt, leveling elevators, measuring dimensions, sorting, 1-wire signaling systems and spot burglar alarms.

There are various advertising stunts too, for the wide-awake radio man. For instance, he might paint on a small metal plate an imitation of a push-button and place it on the inside of his show window. An arrow pointing to the button would ask the passer-by to place his or her finger on the "Magic Button" whereupon things would begin to happen! A large wire basket filled with old tubes and lighted from within could be made to revolve on a hidden phonograph turntable. A flasher sign, asking the observer to step into the store and make a guess as to how many tubes are in the basket, offering to the one guessing the closest a set of new tubes for his or her radio, would complete the display.

A million other "action" ideas of worth await the command of the floating-grid relay.

### LIST OF PARTS

One General Transformer Corp. transformer, 675 V. C.T., 6.3 V., 5V.;  
One home-made chassis, 1½ x 4 x 11 ins.;  
One Blum relay, optional;  
One General Transformer Corp. choke, 30 hys. at 30 ma., midget type;  
One Aerovox dry-electrolytic condenser, 8 mf.;  
One I.C.A. 4-prong wafer socket;  
One I.C.A. 5-prong socket;  
One Microhm resistor, 30,000 ohms, 20 W.;  
One Microhm resistor, 20,000 ohms, 10 W.;  
One Microhm resistor, 10,000 ohms, 10 W.;  
Two I.C.A. tip jacks;

Note: If relay is to be used continuously, resistors should be of 75 W. capacity.

## AN IMPROVED LINE-NOISE FILTER FOR ALL-WAVE SETS

(Continued from page 407)

the circuit diagram (Fig. 1) will show that the device is a true filter, very much similar to those used in the power supply of the set, except that the values naturally are different. Resistor R is marked 10 ohms which, though it may seem very low, is the correct value.

## THE NEW "SELF-TUNING" RADIO RECEIVER!

(Continued from page 408)

cause an increase in signal strength and thus a state of balance is reached.

In actual practice, the "automatic tuning circuit" is made in the form shown in the heading illustration and is connected across the plates of the oscillator tuning condenser, which is the most sharply tuned in the usual superhet. receiver. One coil on the movement is connected in the "B" return of the entire radio receiver, to activate the core, while a second coil (the moving one) is connected in the "B plus" I.F. lead. By carefully adjusting the spring tension and the position of the moving plates (which are normally at ½-maximum capacity) the effects of mis-tuning can be entirely done away with.

## NEW FRENCH "RADIO FURNITURE"

(Continued from page 408)

stallation of radio equipment in homes has natural limitations, especially when the radio listener rents or leases his dwelling or apartment. However, furniture with built-in radio equipment such as the examples shown is not limited by the possibilities of a changing residence.

## USEFUL CIRCUIT IDEAS

(Continued from page 406)

### HONORABLE MENTION

**R**EPLACING THE BH TUBE. This tube is quite expensive, but when the tube is used up it may be replaced very cheaply with an ordinary type 80. An adapter may be made as shown in Fig. 9 which enables the 80 to be put into the circuit very neatly. A tube base is used for the plug.  
ARTHUR STEINBERG

### HONORABLE MENTION

**E**XTRA AUDIO STAGE. When receiving a weak-station program it is often helpful to switch an extra A.F. stage into the circuit, to bring up the level so that it is easier to hear the station. In Fig. 10 may be seen the circuit that I use for this purpose. The second A.F. stage is always lighted, so that when the switches are thrown the signal comes in immediately.  
JOS. C. VILLANDRIE

### HONORABLE MENTION

**T**YPE 106 SPEAKER FIELD SUPPLY. The original copper-oxide rectifier units for RCA 106 speakers run about \$8.00 for replacements. By using the simple circuit shown in Fig. 11, a very effective field supply may be made for a few dollars. A power cord resistor may be used in place of R in the circuit.  
K. B. YOUNG

Please Say That You Saw It in RADIO-CRAFT

# NOW READY!

## VOLUME 2 of the Official REFRIGERATION SERVICE MANUAL

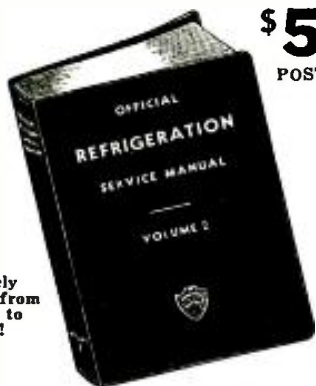

**\$5.00**  
POSTPAID

Entirely  
New from  
Cover to  
Cover!

### The Only Complete Refrigeration Service Manual Ever Published

The new volume of the OFFICIAL REFRIGERATION SERVICE MANUAL (Volume II) contains entirely new service data and information of value to everyone interested in refrigeration.

This Manual forms a companion and supplement to the previous OFFICIAL REFRIGERATION SERVICE MANUAL (Volume I), since all data in the 1935 volume are entirely new.

The curve of sales of refrigerators and replacement parts has steadily increased year by year—even during depression years. It is the one industry to make this progress. Year by year sales increases will soon place Refrigeration in rank with the automobile industry in importance.

### Partial Contents in Second Volume of "Official Refrigeration Service Manual"

- Theory and Fundamental Laws
- Methods of Refrigeration
- Refrigerants, Lubricants and Brines
- Handling and Storage of Refrigerants
- Compression System of Refrigeration
- Liquid Throttle Devices
- Refrigeration Systems
- Electric Control Devices
- Compressors, Types, Seals, Valves, Capacities
- Evaporators and Cooling Units
- Service Tools
- Commercial Unit Specifications
- Servicing Refrigeration Apparatus
- Servicing Low Side Float Valve Systems
- Servicing High Side Float Valve Systems
- Servicing Expansion Valve Systems
- Servicing Thermostatic Valve Systems
- Servicing Restrictor and Capillary Tube Systems
- Charging Systems with Refrigerant
- Electrical Service: Motor, Fuses, Hookups
- Estimating Refrigeration Loads

**OVER 350 PAGES**  
**OVER 300 DIAGRAMS**  
*Flexible, Looseleaf Binder*

This New Refrigeration Manual is printed on a special Bible stock. This stock, although unusually thin, is exceptionally strong and durable. It makes handling of the book much easier.

**GERNSBACK PUBLICATIONS, INC.**  
99 HUDSON STREET, NEW YORK, N. Y.

### MAIL COUPON TODAY

GERNSBACK PUBLICATIONS, Inc. RC-136  
99 Hudson Street, New York, N. Y.

Gentlemen:—Enclosed you will find my remittance of \$5.00, for which send me one copy of the OFFICIAL REFRIGERATION SERVICE MANUAL (Volume II). I understand that this book is to be shipped to me POSTAGE PREPAID.

Name .....

Address .....

City..... State.....

### OVERSEAS READERS!

This book can be obtained from  
**POWER CONTRACTS, Ltd.**  
138 Southwark St., London, S.E.1, England

## NOVEL A.C.-D.C. PHONO.-P.A. SYSTEM

(Continued from page 410)

an even speed while a gear shift arrangement enables the turntable to be operated either at 33 $\frac{1}{3}$  or 78 r.p.m.

The phonograph pickup is of the crystal type giving true high-fidelity reproduction with only 2 ozs. of weight on the needle.

### SPECIAL A.C.-D.C. AMPLIFIER

The amplifier is the result of five years of development and experience with universal A.C.-D.C. units. The type 48 tubes, which are designed for use on D.C., offered so much greater power output than any of the A.C.-D.C. types that some experimental work seemed to be well justified. The chief difficulty proved to be the lack of uniformity in the tubes which made it very difficult to match them up for use in a push-pull circuit without excessive A.C. hum. This was finally overcome by a balancing arrangement in the screen-grid circuit as shown in the circuit (patent applied for). By a simple screwdriver adjustment, hum from this source can be completely eliminated. Three stages of amplification are used. The first is a type 76 tube resistance-coupled to a second 76 which feeds into the push-pull input transformer. The two 48s of course are used in the last stage. To obtain the greatest possible output (over 5 W.) from these tubes, a 22 $\frac{1}{2}$  V. "C" battery is used to furnish grid bias and to leave the full line voltage available for the plates of the tubes. Since no current is drawn from the battery, it lasts for well over a year. Two 25Z5 rectifiers are used with the output circuits connected in parallel. Extremely effective filtering is provided to eliminate A.C. hum; 72 mfs. of filter capacity are used in connection with a choke and resistance filter circuit!

## AN EASILY-BUILT SHORT WAVE PRESELECTOR

(Continued from page 412)

input level, the ratio of signal strength to tube noise is greatly reduced.

### LIST OF PARTS

- One Miller 3-tube preselector coil kit No. 302 (kit consists of: 1, antenna coil, No. 302; 1, R.F. coil, No. 302; 1, R.F. choke coil, No. 750; 1, 6P5T switch, No. 302; 3, dual trimmer condensers, No. 35);
- One Miller metal cabinet, No. 302;
- One Miller dial, No. 150;
- One Miller preselector chassis, No. 302;
- One Miller variable condenser, 2 gang, 350 mmf., No. 2102;
- Three Miller wafer sockets;
- Two Miller tie points, No. 1510;
- One Stancor or General power transformer;
- One Stancor or General 15-hy. filter choke;
- One Solar electrolytic condenser, 4 mf., 450 V.;
- One Lafayette A.C. switch;
- One Lafayette double antenna binding post;
- One Lafayette triple antenna binding post;
- Two National Union tube shields with bases;
- One Blan A.C. cord and plug;
- One IRC carbon resistor, 200 ohms, 1 W.;
- One IRC carbon resistor, 15,000 ohms, 1 W.;
- One IRC carbon resistor, 20,000 ohms, 1 W.;
- One Aerovox mica condenser, .002-mf.;
- Three Aerovox bypass condensers, .1-mf., 400 V.;
- One RCA Radiotron, or Raytheon type 80 rectifier tube;
- Two RCA Radiotron, or Raytheon type 58 R.F. amplifier tubes;
- Misc.: 2 screen-grid clips; 3 knobs; 2 ft., No. 16 buss-bar wire; 10 ft. hookup wire; hardware.

Coil details for the preselector.

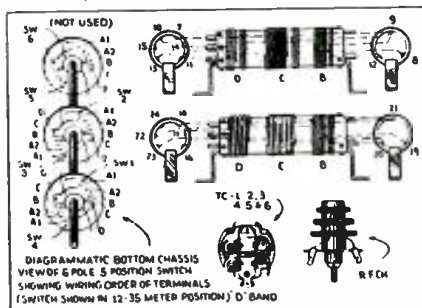

# ALL-METAL TUBES PRESENT NEW SERVICE PROBLEMS

## Headquarters for Tube

Information Now Available  
To Radio Service Men

## Special to Service Engineers

NEW YORK, N. Y.—The almost overnight growth in popularity of all-metal tubes has made the service man an indispensable factor in the maintenance of radio reception.

The service man in turn must depend upon test instruments and service equipment as never before. The Radio Technician turns to a different manufacturer for each make of set, in order to secure schematic diagrams and service hints; but when it comes to problems involving the function of tubes in the radio circuit (no matter what standard type) he may submit his questions to the HEADQUARTERS for Tube Information.

Raytheon recognizes the radio service man's importance and is making every effort to cooperate: If you need up-to-date test instruments and efficient servicing equipment send for the Raytheon Broadside. It explains in detail how you can get them in tube deals. It's free!

The 8th Edition Tube Chart including characteristics of "G" type and all-metal tubes is just off the press. A postal card will bring it to you.

Tube Talks (including Tube Complements with over 2,000 standard models) a big loose-leaf book is available at 50¢\* (\*this includes free service supplements to be issued periodically.)

Finally if you have any tube problems or questions write to the nearest address below.

### HEADQUARTERS FOR TUBE INFORMATION Raytheon Production Corporation

90 East 42nd Street, New York, N. Y.  
56 Chapel Street, Newton, Massachusetts  
445 Lake Shore Drive, Chicago, Illinois  
656 Howard Street, San Francisco, Calif.

Please Say That You Saw It in RADIO-CRAFT



**Radio's Latest Developments**  
**WHOLESALE RADIO'S**  
**New 1936 CATALOG!**

**196 Pages Crammed With Bargains at Lowest Wholesale Prices**

Just off the Press! Over 50,000 items! Every latest radio development, every last minute improvement. Newest sets from 2-24 tubes, parts, tubes, kits, tools and accessories; Short Wave and Xciting Equipment; Nationally known lines. Quality approved parts for all radio construction kits. Buy from the World's Largest Stock at Lowest Wholesale Prices and save money. Send coupon for your FREE copy of radio's latest, greatest Bargain Book.

**Parts can be supplied for any kit described in this magazine**

**RUSH THIS COUPON FREE!**

Wholesale Radio Service Company  
 100 Sixth Ave., Dept. C-16, New York, N. Y.

Please rush FREE copy of your new 196 Price Catalog for 1936, listing over 50,000 items.

Name.....  
 Address.....  
 City..... State.....

**THE LISTENING POST FOR ALL-WAVE DX-ERS**

(Continued from page 409)

stations are fairly well heard throughout the winter. The reception of European stations is almost unknown on the Pacific coast, although there have been cases of such reception reported. South American stations are rarely heard in the early evening hours, but are quite well received on special broadcasts after the Pacific Coast stations have signed off for the night.

**EUROPEAN DX RECEPTION TABLE**

TIME IS EASTERN STANDARD

Station Location	Kc.	KW.	Week Days	Sundays
			a.m. p.m.	a.m. p.m.
Budapest, Hungary	544.6	120	12:45-6:15	
Beromunster, Switzerland	556	100	6:00-4:30*	1:30-4:30*
Athlone, Irish Free State	565	60	8:30-6:00	8:00-6:00
Stuttgart, Germany	574	100	11:45 p.m.-8:00	12:00-8:00
Grenoble, France	593	15	3:00-5:30*	3:00-6:00*
Vienna, Austria	592	120	3:10-7:00	2:15-7:00
Florence, Italy	610	20	1:30-5:30*	3:10-5:30
Brussels I, Belgium	619.5	15	6:55-6:00	4:45-7:00
Lisbon, Portugal (Emissora Nac.)	629	20	7:00-7:00	7:00-7:00
Prague, Czechoslovakia	638	120	12:30-5:30*	12:30-5:30
Lyon La Doua, France	648	100	2:15-6:00	2:15-6:00
Cologne, Germany	657.6	100	12:00-6:00	12:00-6:00
North Regional, Gt. Britain	668	50	5:15-7:00	7:30-5:45
Sottens, Switzerland	677	50	6:30-4:30	3:55-4:30
Paris PTT, France	685	100	3:00-6:30*	3:00-6:00
Stockholm, Sweden	704	55	1:45-5:00	3:00-5:00
Rome, Italy	713	50	1:30-5:30*	3:35-5:30*
Seville, Spain	731	5 1/2	2:30-4:30	2:30-4:30
Munich, Germany	740	100	12:00-6:00	12:00-6:00
Marseilles, France	749	5	2:45-5:00*	2:45-6:30*
Scottish Regional, Gt. Britain	767	50	5:15-7:00	7:30-5:30
Toulouse, France	776	100	3:30-5:30*	3:30-5:30
Leipzig, Germany	785	120	11:50 p.m.-6:00	12:00-6:00
Barcelona, Spain	795	7 1/2	2:15-7:00	2:15-7:00
Lwow, Poland	796	16	1:00-6:00*	1:00-6:00
West Regional, Gt. Britain	804	50	5:15-7:00	7:30-5:45
Milan, Italy	814	50	1:30-5:30	3:30-5:30
Bucarest, Romania	823	12	6:00-5:30	4:30-6:30
Moscow, U.S.S.R.	832	100	9:00-4:30	9:00-4:30
Berlin, Germany	841	100	12:00-6:00	12:00-7:00
Strasbourg, France	859	35	5:15-7:00*	4:30-7:00
Poznan, Poland	869	16	1:00-6:00*	1:00-6:00
London Regional, Gt. Britain	877	50	5:15-7:00	7:30-5:45
Graz, Austria	886	7	3:10-7:00	2:15-7:00
Hamburg, Germany	904	100	11:40 p.m.-6:00	12:00-6:00
Toulouse, France (Radio Toulouse)	913	60	3:00-7:30	3:00-7:30
Brno, Czechoslovakia	922	32	12:00-5:30	12:30-5:30
Brussels II, Belgium	931	15	6:57-7:00	5:00-7:00
Algiers, Algeria, North Africa	941	12	8:00-6:00	7:30-6:00
Goteborg, Sweden	941	10	1:45-5:00	3:00-5:00
Breslau, Germany	950	60	11:00 p.m.-6:00	11:00 p.m.-6:00
Poste Parisien, France	959	100	2:10-6:00	2:10-6:00
Genoa, Italy	986	10	1:30-5:30	3:10-5:30
Hilversum, Holland	995	20	2:40-6:10	3:10-6:10
Bratislava, Czechoslovakia	1,004	13 1/2	12:00-5:30	12:30-5:30
Midland Regional, Gt. Britain	1,013	50	5:45-6:15	11:30-5:45
Heilsberg (Konigsberg), Germany	1,031	60	11:00 p.m.-6:00	12:00-6:00
Rennes, France	1,040	40	3:00-5:30*	3:00-5:30
Scottish National, Gt. Britain	1,050	50	5:45-6:15	11:30-5:45
Bari, Italy	1,050	20	1:30-5:30*	3:35-5:30*
Bordeaux-Lafayette, France	1,077	35	3:00-5:30*	3:00-6:00*
Madrid, Spain	1,085	10	3:00-7:00	3:00-7:00
Madona, Latvia	1,104	50	12:00-4:30	2:00-5:00
Moravska Ostrava, Czechoslovakia	1,113	11	12:00-5:30*	12:30-5:30
Radio Normandic, Fecamp, France	1,113	10	2:00-9:00	2:00-9:00
Horbj, Sweden	1,131	10	1:45-5:00	3:00-5:00
Turin, Italy	1,140	7	1:30-5:30*	3:10-5:30*
London, North and West Nationals	1,149	20	5:45-6:15	11:30-5:45
Monte Ceneri, Switzerland	1,167	15	6:00-5:00	4:30-4:30
Frankfurt, Germany	1,195	25	11:45 p.m.-8:00	12:00-8:00
Radio PTT Nord, France (Lille)	1,213	60	3:00-5:30*	2:30-6:00*
Trieste, Italy	1,222	10	1:30-5:30*	3:10-5:30*

NOTE:—\*Means approximate sign off. Irregular because of Concerts.

**RADIO-CRAFT'S FOREIGN DX SCHEDULE DEC.-JAN.**

Sun. Dec. 1, CP4, La Paz, Bolivia, 1,040kc., 2:00-3:00 am E.S.T.

Address: Compania Radio Boliviana, Casilla 637, La Paz, Bolivia.  
 Mon., Dec. 2, RV39, Moscow, U.S.S.R., 832kc., 1:30-2:30 am E.S.T.  
 Address: R. Siglin, Comite de Radiodiffusion, Petrovka No. 12, Moscow, U.S.S.R.  
 Sun., Dec. 8, CMKC, Havana, Cuba, 1,250kc., 2:00-3:00 am E.S.T.  
 Address: Radio Emissora, CMKC, Apartado 466, Santiago de Cuba.  
 Sun., Dec. 22, CMKC, Havana, Cuba, 1,250 kc., 1:00-2:00 am E.S.T.  
 Sun., Dec. 22, Radio Strasbourg, France, 859kc., 1:30-2:30 am E.S.T.  
 Address: Radiodiffusion National, Association Radio Strasbourg P.T.T., Strasbourg No. 63, Strasbourg, France.  
 Tues., Dec. 24, IITO, Turin, Italy, 1,140 kc., 7kw., 1:15-1:45 am E.S.T.  
 Address: E.I.A.R., Via Arsenale 21, Torino, Italy.  
 Wed., Jan. 1, XEPN, Piedras Negras, Coah. Mexico, 590kc., 2:00-9:00 am E.S.T.  
 Sun., Jan. 5, CMKC, Havana, Cuba, 1,250kc., 2:00-3:00 am E.S.T.

**HIGH FREQUENCY HIGHLIGHTS**

DJB, Zeesen, Germany (15.2) is broadcasting the Eastern Asia program simultaneously with DJA, and DJE from 10:30-11:30am E.S.T. with a N.A. beam.  
 SUZ, Cairo, Egypt (13.82) was heard plainly in many parts of the United States on Sunday, Oct. 6th, from 11:50am to 12:35pm E.S.T. upon the occasion of their transmitting a special program from Cairo to the British Broadcasting Corporation in England via Rugby station GBB on (13.59).

The world's most powerful short-wave station nearing completion at Villejust Seine-et-Oise, France with a power of 150,000 W. was scheduled to take the air officially on October 15th. The new station plans a complete empire broadcasting service similar to Daventry, which will include a daily program in English beamed on North America.

A new station HRN, located at Tegucigalpa, Honduras, is now on the air nightly from 8:00-10:00pm E.S.T., and with a special hour for North American listeners on Sundays. HRN broadcasts simultaneously on 5.875mc, and 1.660kc.

Senor Edgar Anzola's short-wave station "Broadcasting Caracas," YV2RC, Caracas, Venezuela has been testing on a new frequency of 5.8mc. This frequency will be retained in the future if it proves more satisfactory than their former frequency of 6.112mc.

That tricky jungle station OPM, one of the most sought for DX goals, is being heard quite frequently of late between 1:30 and 2:30am E.S.T. OPM is on (10.14), and located in Leopoldville, Belgian Congo, Africa.

Commercial station YVQ, Radio Nacional, in Maracay, Venezuela (6.67) is on each Saturday night from 8:00 to 8:30pm E.S.T., relaying short-wave station YV2RC. Station YVR, in Maracay (9.15) occasionally relays the same program.

WOR after dickerer with the Federal Communications Commission for several months has finally decided that it will not put the rumored short-wave relay W2XHI on the air after all.

IRG, Massawa, Eritrea in the middle of the War Zone may be heard working JVH, Nazaki, Japan, Mon., Wed., Fri., between 5:00 and 7:00am E.S.T. (IRG is on 14.74mc.), according to Joe Stokes DX commentator at radio station KDKA.

Two rare and interesting DX goals are the Southern Rhodesian short-wave stations at Salisbury (6mc.) on from 1:15-3:15pm Tuesday; 10:00am-10:45am, and 11:00am-12:00am noon on Friday, and the other station located at Bulawayo on 6.147mc., with the same broadcasting schedule.

Mr. Kuramochi, of the Kokusai-Denwa Kaisha Ltd., Tokyo, Japan, is very anxious for reports on the special transmissions of JVH, Nazaki, Japan (14.6) between 4:00 and 5:00pm E.S.T. on Monday, and Thursday. This particular transmission has been put on experimentally since June 20th, on an antenna beamed especially on the east coast of North and South America. It is hoped shortly to establish a regular permanent schedule for these sections of country.

HCJB, Quito, Ecuador has changed its frequency to approximately 8:47mc.

**MIND POWER**

**A FREE BOOK**

Develop your personal, creative power! Awaken the silent, sleeping forces in your own consciousness. Become Master of your own life. Push aside all obstacles with a new energy you have overlooked. The Rosicrucians know how, and will help you apply the greatest of all powers in man's control. Create health and abundance for yourself. Write for Free book, "The Secret Heritage." It tells how you may receive these teachings for study and use. It means the dawn of a new day for you. Address: Scribe S.L.Q.

**The Rosicrucians**  
 SAN JOSE —AMORC— CALIFORNIA  
 "The Rosicrucians are NOT a religious organization"

**The Raco 339 All-Wave 3-Tube Direct Reading Signal Generator**

(64-17000 K.C. on fundamental) 1% accuracy on all bands 54-17000 K.C. all on fundamentals. Dial calibrated in both meters and kilocycles, modulated or unmodulated as desired by means of on-off switch. Attenuation control—Universal operation (A.C.—D.C.) Electron coupled Generation. The 339 has a 6C5 RF oscillator, a 37 rectifier tube, so that D.C. is used on the plate, while modulation is provided by a neon tube relaxation oscillator at a frequency of about 1000 cycles. Wired, tested, calibrated. \$16.00

**RACO RADIO CONSTRUCTORS LABORATORIES**  
 136 Liberty St., N. Y. C., N. Y. Dept. RC4

**EVEREADY SERVICE CEMENT**  
 "The Original Speaker Cement"

This is the best cement for replacing speaker cones, or repairing old rattling or torn cones. It can be used for other Radio work, such as sealing adjustments, cementing loose tube bases, etc. It is Vibration Proof and Fast Drying. Ask for it by name, at your jobbers, if he can not supply you, write us. Send for large circular of other Service Aids. List Price, 50c. per large bottle.

**General Cement Mfg. Co., Rockford, Illinois**

**RADIO ENGINEERING**

RCA Institutes offers an intensive course of high standard embracing all phases of Radio. Practical training with modern equipment at New York and Chicago schools. Also specialized courses and Home Study Courses under "No obligation" plan. Catalog, Dept. RT-38

**RCA INSTITUTES, Inc.**  
 75 Varick St., New York. 1154 Merchandise Mart, Chicago  
 Recognized Standard in Radio Instruction Since 1909

Please Say That You Saw It in RADIO-CRAFT



## AIR CONDITIONING is America's Next Great Industry

THE idea of electricians, radio service men and other mechanically inclined men servicing Air Conditioning and Refrigeration Units is self-evident and the thought has occurred to some untold thousands ever since air conditioning equipment has been installed in public auditoriums, theatres, studios, department stores, office buildings and manufacturing plants. The tremendously broad possibilities in this new industry are bound to give employment and success to men far-sighted enough to see its advancement and development.

### Well-known Engineer Edits Manual

The OFFICIAL AIR CONDITIONING SERVICE MANUAL is edited by L. K. Wright, an expert and a leading authority on air conditioning and refrigeration. In this Air Conditioning Service Manual nearly every page is illustrated; every modern installation and individual part carefully explained; diagrams furnished of all known equipment; special care given to the servicing and installation end. The tools needed are illustrated and explained; there are plenty of charts and page after page of service data.

### CONTENTS IN BRIEF

History of Air Conditioning; Fundamental Laws; Methods of Refrigeration; Ejector System of Refrigeration; Compression System of Refrigeration; Refrigerants; Lubricating Oils; Liquid Throttle Devices; Servicing Expansion and Float Valves; Servicing Refrigerating Systems; Control Devices; Thermodynamics of Air Conditioning; Weather in the United States; The Field of Air Conditioning; Insulating Materials; Heat Transmission Through Walls; Complete Air Conditioning Systems; Estimating Requirements for the Home, Small Store, Restaurant's Layout of Duct Systems; Starting Up a System; Operating and Servicing Air Conditioning Systems; Air Filtration, Ventilating and Noise Eliminating Devices; Portable Electric Humidifiers and Room Coolers; Automatic Humidifiers; Air Conditioning Units for Radiator Systems and Warm Air Systems; Central Conditioning Units, etc.

**352 Pages**  
**600 Illustrations**  
9x12 Inches

Flexible, Loose-Leaf  
Leatherette Cover

**\$5.00** A COPY



(Send remittance by check, money order or unused U.S. Stamps. Register letter if it contains stamps or currency.)

**GERNSBACK PUBLICATIONS, INC.**  
99R Hudson Street New York, N. Y.

## Something NEW!

WEATHER  
FORECASTER  
AND  
HUMIDITY  
TESTER  
"HYGROSCOPE"

The Ace of Weather  
Forecasters



When placed in a well-ventilated room or in the fresh air, the HYGROSCOPE foretells coming weather conditions from eight to twenty-four hours in advance. It also accurately records outdoor humidity, and when placed inside it gives the humidity within the house or room.

The HYGROSCOPE is automatic self-adjustable, simple American-precision made. It cannot get out of order at any time. The dial measures 2 3/4", is enclosed in a 6" round hardwood case, with either walnut or mahogany finish. It is attractive for desk or living room.

### OUTSIDE DIAL FORECASTS WEATHER

Fair—rain—or changeable is indicated on the outer dial when the HYGROSCOPE is placed in a well-ventilated room or out-of-doors. If indoors, place the instrument near an open window.

### INNER DIAL SHOWS THE HUMIDITY CONTENT

The HYGROSCOPE also acts as a hygrometer. Numbers on the inner dial indicate the degree of humidity present in the air and in artificially heated rooms.

SEND YOUR ORDER NOW! Get your HYGROSCOPE today. Your remittance in form of check or money order accepted. If you send cash or unused U. S. Postage Stamps, be sure to register your letter. Also specify if you prefer the HYGROSCOPE in Walnut or Mahogany.

Postpaid

**GRENPARK COMPANY**

Dept. RC-136  
99 Hudson St. - New York, N. Y.

## AN "ACORN"-TUBE V.-T. VOLTMETER

(Continued from page 415)

ready for assembly. Also, the design has been so well thought out that no complicated assembly is necessary. It might be well to point out that, since this is a precision type of instrument, clean, well-soldered joints throughout are absolutely essential, if accuracy is to be maintained. Any points of doubt in construction can be dispelled by reference to the drawings (Figs. 1 and 2) which are self-explanatory.

The meter is so well bypassed that calibration made at 60 cycles will hold true at 25 mcs. The simple calibration circuit shown in Fig. 3 will be found quite adequate. It will be necessary to use as accurate a meter as possible across the A.C. circuit, in order to obtain accuracy of calibration in the finished instrument. Since each instrument is individually calibrated, any sensitive meter may be used with the meter itself, but it should not be of higher scale reading than 500 microamperes.

Calibration charts should be made for each instrument, since they vary somewhat; they should approximate Fig. 4 fairly closely.

To make the charts, it is simply necessary to connect the calibration circuit to the probe terminals, and vary the potentiometer to get even scale readings on the A.C. meter, then mark the corresponding readings of the meter of the V.T.-V.M. circuit on the chart paper. The meter may of course be calibrated at any frequency higher than 60 cycles, but the latter is the most readily available.

Before turning the instrument on at any time it will be advisable to turn the bucking controls so that the meter will not be deflected off-scale.

### LIST OF PARTS\*

- One 2,000 ohm wire-wound resistor, R1;
- One 50,000 ohm wire-wound resistor, R2;
- One 10,000 ohm wire-wound resistor, R3;
- One 40,000 ohm potentiometer, R4;
- One 2,000 ohm potentiometer, R5;
- One dual 500 mmf. cond., C1, C3;
- One 10 mf. electrolytic cond., C2;
- One D.P.S.T. toggle switch, Sw. 1;
- One S.P.D.T. toggle switch, Sw. 2;
- One 5-prong bakelite socket;
- One 5-prong plug;
- One control unit box;
- One control unit panel;
- One "acorn"-tube socket;
- One "acorn"-tube housing;
- One rubber housing insulation;
- Two potentiometer dial plates;
- Two potentiometer dial knobs;
- One shielded 4-wire cable;
- One rubber grommet;
- All necessary hardware, wire, etc.

\*The above parts are supplied in the I.C.A. kit. The following accessories also are needed: One microammeter 0 to 500 (or less) microamperes, M; One R.C.A. Radiotron type 954 "acorn" pentode, V; Four dry cells (or other 6 V. filament source); One 67.5 V. "B" battery for plate supply; One 22 1/2 V. battery for bucking voltage.

Fig. 4. Approximate calibration curves for the V.-T. voltmeter.

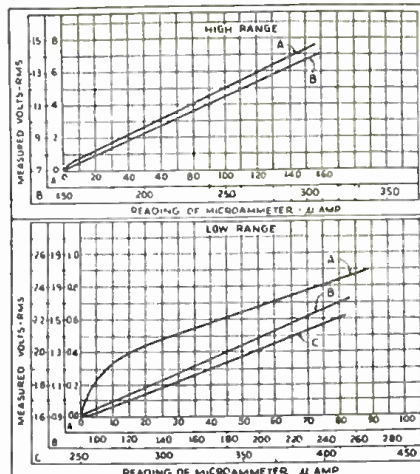

Today's  
MOST Distinguished  
Radio Achievement



## CUSTOM BUILT ROYALE 24-TUBE Radio

THIS super radio-musical instrument was created for those discriminating and exacting few who insist on the finest, most beautiful, most precisely built radio obtainable. A set of rare distinction, musically and artistically perfect, the Royale offers over 100 features... assuring a luxurious and idealized type of brilliant, sparkling, guaranteed world-wide performance... heretofore unattainable. It is today's only "aged" radio... offers 6 tuning ranges... 1/2 to 2400 meters... etc.

This 24-tube achievement outperforms other receivers. Assures Unlimited Scope Full Fidelity. Audio range is 20 to 16,000 cycles per second... 40 watts undistorted output. Fully guaranteed for 5 years... absolute satisfaction assured

The 30-day FREE Trial Offer enables you to try the Royale in your own home, without obligation. Write for literature now or mail coupon TODAY.



**ROYALE RADIO CRAFTERS**  
(Division Midwest Radio Corporation)  
Dept. 206G, Cincinnati, Ohio.

Without obligation, send me literature describing Custom-Built 24-Tube 6-Tuning Range, Royale Radio... and details of your 30-day Free Trial Plan.

Name.....  
Street.....  
Town..... State.....

QUALITY recommends

Condensers  
by  
**SOLAR**

WET... DRY  
PAPER  
MICA... TRIMMER



Please Write for Details  
**SOLAR MFG. CORP.** 598-601 Broadway  
New York City



**ELECTRICAL BOOKS**  
shipped  
**FREE**

**10 BIG BOOKS**

**A-C-RADIO TELEVISION**  
EVERY ELECTRICAL SUBJECT COVERED

Here's great news for anybody interested in Electricity. BRAND NEW edition of Applied Electricity brought right down to date with every NEW Electrical subject fully covered. 10 big Volumes and all shipped FREE for examination. See special offer below.

**For Beginners and Experts**  
Over 3000 pages—hundreds of illustrations—the most complete work of its kind ever published. Diagrams, motor, power stations, radios, television, everything electrical explained clearly so anyone can understand them.

**BIG FIELD! Big Demand! Big Pay!** Men who understand electricity are urgently needed right now in thousands of industries. Autos, airplanes, machine shops—practically every industry depends on electricity and men who know this subject make big money. Pleasant, fascinating work, easy to learn and do. Send coupon for a set of these books for FREE examination.

**FREE** S. Gernsback's famous Radio Encyclopedia (latest edition) given free with these electrical books if you send NOW. Invaluable to any radio worker. Covers whole Radio field.

American Technical Society, Drexel at 50th St., Dept. E 126, Chicago

Send for 10 days' free use. BRAND NEW 10 volume set of Electrical Engineering. Include free membership in the American Technical Society and S. Gernsback's Encyclopedia. I will pay the few cents delivery charges on the books. If I wish I may return them in 10 days and owe you nothing, but if I keep them I will send \$2.00 after 10 days, then \$3.00 a month until the special price of only \$29.80 is paid.

Name.....  
Address.....  
City.....State.....

Attach letter stating age, occupation and name and address of employer and at least one business man as reference.

**IDEAL! The FIRST FULLY SEALED AND INSULATED RESISTORS**

IRC INSULATED Resistors bring you EVERY advantage of the famous Metallized resistance principle PLUS full, high voltage insulation. No danger of shorts or opens. Smaller—lighter—vibration-proof—moisture-proof—BOTH color coded AND marked with rank and value. Featured by leading jobbers.

International Resistance Co.  
Philadelphia, Pa. — Toronto, Canada

Metallized IRC INSULATED

**BIG 1936 WHOLESALE CATALOG FREE**

164 Pages — Radio, Electrical and Refrigeration Equipment at lowest prices. A catalog of great value to every dealer, service man and amateur. Complete sets, parts, amateur and commercial apparatus. Write today.

**BURSTEIN-APPLEBEE CO.**  
1012-14 McGee St., Kansas City, Mo.

**STOP GUESSING!**

Radio service is easy when you know just where to look for the trouble. A CHUCKER troubleshooter and repair-price eliminates guess-work in what is wrong and what to charge. Used by progressive servicemen everywhere. Price 50¢ post-paid. (No Stamps.)

**PAUL G. FREED**  
Publishing Division B  
5053 Baltimore Ave., Philadelphia, Pa.

**NEW "SPHERICAL" MICROPHONES ARE NON-DIRECTIONAL**

(Continued from page 410)

by the presence of the microphone, and as a result the pressure at the face of the microphone will not be the same as it was before the microphone was placed in position. This change in pressure caused by the presence of the microphone is largely an effect of diffraction. It is limited to the higher frequencies, varies with the frequency, and is a function of the size and shape of the microphone and the direction from which the sound waves approach the microphone. Because of this, previous microphones have shown a marked directional effect, which not only varied with the angle of sound incidence, but for any one angle varied greatly with frequency.

This varying in response with direction and frequency results in a distortion of the output. In many cases—such as when used as a pick-up for large orchestras or choruses, or in sound picture studios—the sound reaching the microphone directly is only a small part of the total. The major part of the sound reaches the diaphragm only after one or more reflections from the walls of the room. As a result most of the sound arrives at the microphone from directions other than the normal one. If the response in these various directions differ, the output of the microphone will not truly represent the sound at the point of pick-up—and this, of course, is distortion. In the new microphone this directional distortion is so slight as to be imperceptible.

The directional effect for a previous type of moving coil microphone is shown in Fig. 1 for 3 angles. At 10,000 cycles the difference in response between certain angles is 20 db., and at 5,000 cycles may be over 15 db. In the new microphone this variation has been greatly reduced, as shown in Fig. 2. At 10,000 cycles the maximum difference in response for any two directions is only about 5 db., which is imperceptible to the ear. Moreover the new microphone is designed to be mounted so that its diaphragm is horizontal, and thus its response is perfectly uniform for all horizontal angles. The very slight residual directional effect exists only in the vertical plane. When it is used for picking up addresses or other sounds arriving only in the horizontal plane, there is no directional distortion whatever.

**"MIKE" 1/2-IN. IN DIA. IS IDEAL**

This great improvement has been made possible by extensive study of the causes of the directional effect and the possible means of avoiding it. The directional effect is largely a function of the size of the microphone relative to the wavelength of sound. It might be avoided, therefore, if the microphone could be made small enough, but calculations showed that to make the effect negligible at 10,000 cycles, the instrument would have to be approximately 1/2-in. in diameter. While a microphone of this size could have been built its output would be considerably less than for the larger instruments, which is objectionable in a microphone designed for general broadcasting and sound picture use. The size of the new microphone was reduced, therefore, only to the point where a satisfactory output could still be obtained, and the remaining tendency to directional distortion was overcome in the design—chiefly by employing a spherical shape and by using the acoustic screen mounted just in front of the diaphragm.

In many of the earlier types of microphones, the cavity in front of the diaphragm introduced an undesirable resonance. In the new microphone this resonance is controlled by the design of the protective grid, which is that part of the outer shell directly in front of the diaphragm. Instead of being the source of undesirable distortion, the grid and cavity have become a valuable aid in improving the response of the instrument at very high frequencies. This grid also incorporates a screen to prevent dust and magnetic particles from collecting on the diaphragm.

**PISTON ACTION IMPORTANT**

The inherent loss due to the reduction in size is partially offset by making the diaphragm light in weight and of very low stiffness. It is very important that the diaphragm should vibrate as a simple piston throughout the entire range. To secure such action over a wide range of fre-

quencies has proved in the past to be a very difficult problem. This problem has been solved quite satisfactorily in connection with the new microphone. No evidence of vibrating in other modes (Chladni figures, for instance—Editor) is shown by the diaphragm below 15,000 cycles.

The acoustic screen that compensates for the directional effects is mounted over the grid in front of the diaphragm, and is thus an additional protection for the diaphragm. This places it in a vulnerable position, however, but it is designed to withstand considerable shock and the acoustic screen itself is a separate unit and easily replaceable. The terminals of the microphone are provided in the form of a plug recessed in the housing behind the microphone unit. This arrangement provides protection for the terminals and conceals the connecting jack.

Thorough-going research and development studies have thus not only made it possible to provide a microphone that is smaller, more easily handled, and more attractive in appearance than previous types, but have extended the frequency range and reduced the directional effects to a point where they are imperceptible. Its convenient form and desirable characteristics make the new microphone suitable for practically any type of service.

(This concludes a discussion, of the dynamic-type—moving coil—microphone, by R. N. Marshall, member, technical staff, Bell Tel. Labs. The following data, by another writer, discusses the *astatic-type*—Rochelle salt crystal—microphone.—Editor)

**"ASTATIC" OR CRYSTAL-TYPE NON-DIRECTIONAL MICROPHONE**

An announcement of unusual interest to microphone users is the recently completed development of a "spheroid" crystal microphone with remarkable new performance and constructional features. The "Spheroid" is a product of Shure Brothers Company.

As may be inferred from the name, the new microphone has the form of a sphere, and is only 2 1/4 ins. in dia. (See the "mike" at lower right.) Sound enters the unit through a horizontal annular slot, and because of this symmetry of construction, pick-up is perfectly non-directional throughout a complete angle of 360 deg.

The frequency characteristic of the "spheroid" provides true high-fidelity reproduction with a wave-response within 5 db. from 40 to 10,000 cycles. Due to the complete absence of horizontal directivity, this frequency response characteristic is not changed for sound approaching from any direction in the horizontal plane.

The "spheroid" is the first crystal microphone which combines high output level with non-directional high-fidelity wave response. The crystal element is a newly-developed "Grafoil" bismorph (licensed under patents of the Brush Development Company) which is cantilever supported and driven by a specially-shaped, highly efficient, small dural diaphragm, horizontally enclosed within the instrument. This diaphragm and crystal system produces an output level of approximately minus 55 db., (which is believed to be the highest output ever obtained from any commercial high-fidelity crystal microphone, exceeding that of twenty-four cell assemblies.) The "grafoil" crystal is especially advantageous, since it increases the internal capacity and reduces cable losses in addition to providing somewhat higher output.

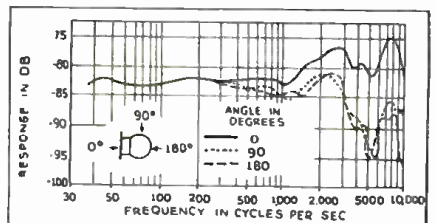
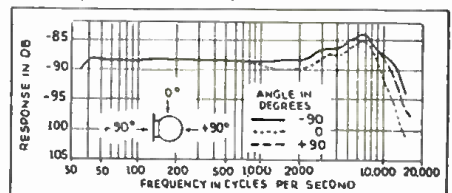

Fig. 1, above. Response of ordinary dynamic mike.  
Fig. 2, below. Response of new mike.



Please Say That You Saw It in RADIO-CRAFT



Here are two NEW **SERVICING THEATRE SOUND SYSTEMS**

**10c BOOKS**

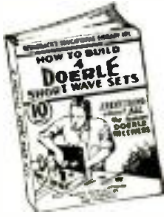

Each book contains 32 pages—and is well illustrated.

LITERALLY the brands of radio fans have built the famous DOERLE Short Wave Radio Receivers. So insistent has been the demand for these receivers, as well as construction details, that this book has been specially published.

**HOW TO MAKE FOUR DOERLE SHORT WAVE SETS**

Contains EVERYTHING that has ever been printed on these famous receivers. These are the famous sets that appeared in the following issues of SHORT WAVE CRAFT: "A 2-Tube Receiver that Reaches the 12,500 Mile Mark," by Walter C. Doerle (Dec. 1931-Jan., 1932); "A 2-Tube 'Signal Gripper,'" by Walter C. Doerle (November, 1932); "Doerle 2-Tube Adapted to A. C. Operation" (July, 1933); "The Doerle 3-Tube 'Signal-Gripper' Electrified," (August, 1933) and "The Doerle 'Gow' Hand-Mounted" (May, 1934).

**HOW TO MAKE THE MOST POPULAR ALL-WAVE 1- and 2-TUBE RECEIVERS**

THIS book contains a number of excellent sets, some of which have appeared in past issues of RADIO-CRAFT. These sets are not toys but have been carefully engineered. ● The Megadyn 1-Tube Pentode Loudspeaker Set, by Hugo Gerzback. ● Electrifying The Megadyn. ● How To Make a 1-Tube Loudspeaker Set, by W. F. Chesney. ● How To Make a Simple 1-Tube All Wave Electric Set, by W. Green. ● How To Build A Four-In-Two All-Wave Electric Set, by J. T. Bernerlev, and others. And believe it or not, each book contains 32 pages and over 15,000 words of new legible type. Each book is thoroughly modern and up-to-date. They are well illustrated. They are not just a reprint of what was printed before. All the latest improvements have been incorporated into the sets. Remember, these books sell at the extraordinary low price of ten cents each, you can not possibly go wrong in buying them. Despite the low cost, our usual guarantee goes with these books as well—money refunded if not satisfied.



There has never been such a wealth of data published in a low-priced radio book of this type in the history of the radio publishing business.

**RADIO PUBLICATIONS**  
99 (RC) Hudson Street  
New York, N. Y.

**ELECTRIC DRILL**



CAPACITY  
1/4" DRILL  
WEIGHT  
4 1/2 lbs.  
PRICE  
**\$5.97**

This Utility Drill is built for intermittent service, always ready for instant use, and will accommodate straight shank drills up to 1/4 inch. Weighs only 4 1/2 pounds, and has a convenient on-and-off switch mounted on the motor body. The three-jaw chuck has a capacity up to 1/4 inch. Furnished complete with 10 feet of heavy duty rubber covered cord, and plug cap. Operates on alternating current only. 110 volts, 60 cycles.

Shipping weight 5 pounds.

OUR OLD CUSTOMERS KNOW THAT OUR MERCHANDISE IS SOLD ON A STRICT MONEY-BACK GUARANTEE.

All shipments will be forwarded by express collect if not sufficient postage included with your order.

WELLWORTH TRADING CO., RC-136  
506 Palmolive Bldg., Chicago, Ill.

Enclosed find \$.....for which ship to address below

ELECTRIC DRILL

NAME .....

ADDRESS .....

CITY..... STATE.....

(Continued from page 411)

very necessary in obtaining maximum frequency response from any amplifier and in replacing such parts be sure that these parts are properly matched. The output of circuits as in Fig. 7D, are usually resistance-capacity coupled directly into the first stage of the A.F. amplifier.

**FADER TROUBLES**

Faders are used in practically all high priced equipment installations and are quite advantageous to the creation of the "Perfect Illusion." They consist of resistance stages to gradually lower the output from the head amplifier to the A.F. amplifier. At dead-center (where the sound is completely cut off from both units) is the change-over switch, that is, the S.P.D.T. switch used to change the exciter lamp voltage from one machine to the other. Some faders also have a shunt switch at dead-center. This is across the A.F. amplifier output and closes just before the exciter line is opened. It remains closed until the exciter line to the other unit is closed, then opens, providing a silent change-over.

Most fader troubles can be traced to bad contact between the movable arm and the stationary contact points. Adjustable spring tension is provided for in most fader arms. After the contacts are faced off with a fine, flat file and fine sandpaper, the arm spring adjustment may be made until the proper amount of tension for good contact is provided.

Faders in most installations are provided with an extension or remote control. If not properly installed they will cause a pull on the fader proper, making a tighter contact on one side than on the other and eventually wearing the points down so that contact will be made only on the "high" side. This can be easily checked by rotating the fader and sighting along each point of contact. When necessary, line-up the extension or the fader body with shims until no drag is placed on the main unit.

Fader resistance trouble may be traced to open sections of wire on the forms, and to corroded or poorly-soldered joints. In the case of vitrolized resistors the wire will sometimes corrode under the coating and cause an arcing or frying noise in the sound; or possibly open up and "kill" the sound at some points on the fader. Earlier fader equipment came with a D.P.D.T. switch (film-disc). In some instances the writer has found the small contacts corroded enough to allow no sound at all to pass through. The best remedy for this sort of trouble (when both sides of the switch are not used) is to remove it from the circuit, or bridge it across.

**OTHER TROUBLES**

In the latter, smaller amplifiers, the preamplifier, changeover, volume control and A.F. amplifier are all built into one case, the volume control and change-over switch being separate units. Volume controls are generally in the grid circuit and in the first or second stages—the change-over being merely a S.P.D.T. switch for the exciter lamps. With such change-overs, there is likely to be a sudden "cutoff" of sound from one machine and a sharp "comeon" from the other. This is due to a small amount of time required for the second exciter filament to heat sufficiently to energize the P.E. cell. An exciter lamp of lower watts rating will decrease this time lag but may increase the amount of A.C. hum.

With the smaller amplifiers using a very high degree of gain in the first stage, there is likely to be a noticeable hum at normal volume levels. This may be due to A.C. on the exciter lamp filament and to the background noise from the first stage, that is, electronic space-charge disturbance within the tube itself. Thorough bonding of all units to a common, good ground will help, as well as making the P.E. cell cables as short as possible. Defective cables will cause considerable loss in the high A.F. transmission even in short lengths. When replacing such cables be sure that they are properly grounded both electrically and mechanically at both ends. Ungrounded cables rubbing against grounded equipment will cause considerable noise in the sound.

**CORRECT PE. CELL VOLTAGE**

If the amplifier provides P.E. cell voltage adjustments, the technician might try operating

**Sears**  
Lead in Radio Parts and P. A. System Values



**\$27.25** CASH  
Sold On Easy Terms  
**\$6.50** DOWN

**15-24 WATT AMPLIFIER**

- 6B5 Class A Power Amplification.
- Uses Carbon or Crystal Mike without Preamplification.
- Master Tone Control.
- Automatic Impedance Matching for one or two speakers.
- Plug-In Connections for quick set ups.
- Built-in 20 Watts Field Supply and Mike Transformer—no extras to buy.

This is but one of the three thousand outstanding Bargains Sears offer you in our Radio Parts Catalog. Sears carry a complete line of amplifiers, P.A. systems and Associate equipment; a wide selection of the very latest Testing Equipment for servicing either metal or glass tube equipped radio receivers. Also a comprehensive selection of condensers, coils, transformers, resistors, etc., for Radio Servicemen, Amateurs and Experimenters. Hundreds of new, and interesting gadgets and accessories for repairing old sets or building new ones. All priced to save you money and all backed by Sears iron clad guarantee of satisfaction with every purchase.



**FREE**  
68 Page Catalog of Radio Supplies, P. A. Equipment and Amateur needs, of which many items can be bought on **EASY TERMS**

**RUSH THIS COUPON TO US FOR OUR NEW CATALOG—SAVE UP TO 50% on RADIO SUPPLIES**

Sears, Roebuck and Co., Homan and Arthington Sts., Chicago, Ill.

Please send me your new 1936 catalog, K653RC, of Radio Parts and Supplies.

Name .....

Address .....

City..... State.....

**RADIO** biggest opportunities still ahead

ALMOST in a decade radio has become a giant industry. The opportunities created will be enjoyed by trained men. The International Correspondence Schools Radio Course, prepared by leading authorities and constantly revised, will make you a trained man! A fascinating book—free.

**INTERNATIONAL CORRESPONDENCE SCHOOLS**

Box 6679-B, Scranton, Penna.

Send me—free—information on subject checked:

Radio  Radio Service Man

Radio Operator  Electrical Engineer

Name .....

Address .....

Please Say That You Saw It in RADIO-CRAFT



# STENTORIAN

## SOUND AMPLIFIER NUCLEUS

*Remember*—build your Amplifiers the STENTORIAN way—for the finest results at the lowest cost—Power Supply Units are the nucleus—the very backbone of Sound Amplifiers!

You'll find that STENTORIAN way Sound Amplifiers give strong, clear, brilliant volume for auditoriums, ballrooms, convention halls, lodge halls, political rallies, banquet programs, night clubs, taverns, office and factory call systems, depot train call systems, truck and auto advertising, athletic fields, race track announcements, concession barkers and the like.

The STENTORIAN NUCLEUS includes perfectly matched push-pull impregnated power transformer, chokes, audios, and outputs, plus an attractive black wrinkle-finished chassis equipped with lettered output and input terminal strips and marked tube sockets—for 6, 10, 15, and 30 watt Amplifiers, Class A and AB amplification, 2.5 and 6.3 volt tubes. Nuclei for two additional 6 and 15 watt Amplifiers—using the new All Metal tubes; for crystal or condenser mike Pre-amplifiers; and for small Class B Battery Amplifier.

Don't delay—send now for full details!

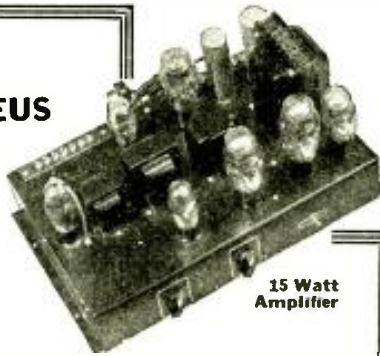

15 Watt Amplifier

*Free for the Asking!*

Interesting fully illustrated bulletin on the STENTORIAN Sound Amplifier Nucleus and name of our nearest distributor.

THE "STENTORIAN" WAY IS THE MOST ECONOMICAL WAY FOR QUALITY SOUND AMPLIFIERS.

**GENERAL TRANSFORMER CORPORATION**  
504 South Throop Street Chicago, Illinois  
*Manufacturers of Replacement Units*

## SERVICING THEATRE SOUND SYSTEMS

(Continued from page 437)

the cells at a higher voltage so that the volume control proper could be turned back a little and still provide normal volume. However, too much voltage on the cells will cause ionization. This can be detected by the bluish haze within the tube. Overloading the cell in this manner tends to shorten its life, causes mushiness and distortion and if overloaded too much, results in motorboating in the sound output. Also try different tubes in the first stages to get the background noise to a minimum.

One popular make of low-priced equipment uses a 3-gang change-over switch with a common shaft. The front bearing for the shaft is usually grounded directly to the chassis. One circuit returns to ground through the shaft and through the bearing. In some instances the shaft has become sufficiently coated with oil or corrosion to form a high-resistance path to ground, causing a high-pitched whistle in the sound. Bonding the shaft directly to the chassis with a flexible pictail lead will permanently eliminate the trouble without taking the switch apart and cleaning the bearing and shaft.

### THE A.F. AMPLIFIER

Audio frequency amplifiers are of the same basic construction and should not offer any great difficulty in servicing them. They are all composed of transformers, chokes, condensers, resistors and tubes and may be dealt with according to the methods used in servicing other similar equipment.

In replacing high-leakage or shorted condensers the main thing is to have the correct capacity with sufficient safety factor in the working-voltage rating. With resistors, the chief concern is the safety factor on the power rating, so that the resistor will dissipate the heat without overload. Great care should be used on A.F. transformer replacement to see that the stages are properly matched, especially the input and output transformers.

Sufficient current carrying capacity is very important in power transformer replacement in order to insure against burnouts; also sufficient primary taps to compensate for line-voltage variation. Another important item in power transformer replacement is the proper primary winding for the specified A.C. voltage (110-220 V.) and frequency (25-60 cycles). Filter choke replacements require correct inductance, as well as ability to safely pass the circuit current.

Rectifier and output tubes should be watched closely for signs of weakness. When power tubes get weak the current consumption drops and the voltage increases, perhaps enough to overload and damage the other constituents of the circuit. Gassy rectifier tubes may overload power transformers, and perhaps increase the voltage across the filter condensers and short them through.

Output transformers generally provide windings between 4 and 16 ohms impedance (measured at about 400 cycles) for dynamic or permanent-magnet monitor voice coils or 2,000 to 4,500 ohms impedance for magnetic monitors. Coupling transformers are sometimes used from the high-impedance windings to the low-impedance windings for the dynamic or permanent-magnet monitor voice coils. The usual coupling to the stage speaker or speakers is made from a 500 ohm impedance winding on the output transformer. A matching transformer being used at the stage end to couple to the 4 to 16 ohm impedance voice coils of the speaker unit or units. This type of coupling is used to minimize line loss from the booth to the stage, being less at 500 ohms than at 4 or 16 ohms.

If, in the event the sound goes to an almost inaudible level and all the amplifier voltages check OK, look for trouble in the output lines. Sometimes earphones or extra speakers coupled across the output impedance will short out and noticeably lower the volume and make the tone harsh and stringy. Voice lines from the booth to the stage should be at least No. 14 wire and should be spaced not less than 3 ft. from the A.C. line to the field supply. In extremely long runs use No. 12 wire to minimize line losses.

The third and concluding chapter on servicing talkie equipment discusses loudspeakers and screens.



# "HEAR THAT OXFORD!"

Only in a superlative instrument like the OXFORD SPEAKER do you get the design, materials and workmanship necessary to deliver all the rich, glorious sound that is Radio today. Yet when you consider the limitations imposed on a set or P.A. system by an inferior

speaker, it is a marvel that any but the best is ever used. Certainly it is the only safe buy.

OXFORD SPEAKERS are among the finest, if not THE finest, speakers ever made. Yet they cost no more than other kinds, OXFORD Full Tone, High Fidelity, Morning Glory Type Speakers—fashioned from finest materials and embodying many exclusive features in their advanced design—are available in a wide assortment of types and sizes, with special units built to meet any special engineering requirements.

Inquiries are invited. See your jobber or write us for Bulletin 351-C.



**OXFORD-TARTAK RADIO CORP.**  
350 W. Huron St. Chicago, Illinois

## Tests the NEW METAL TUBES

**\$13.50**

The new Tefft Tube Checker accurately tests over one hundred and fifty different tubes in addition to the new metal tubes. Write for illustrated circulars.

**THE TEFFT RADIO COMPANY**  
PLYMOUTH, MICH.

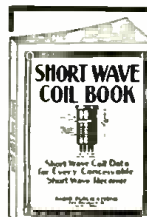

### Every SHORT-WAVE SET-BUILDER NEEDS THIS BOOK

Every experimenter who has ever tried to build a short-wave set knows by experience, the difference between a good and a poor receiver is usually found in the short-wave coils. Often you have to hunt through magazines, books, etc., to find the information you require. The present book has been gotten up to obviate these difficulties.

In this book you find every possible bit of information on coil winding. Only the most modern "dope" has been published. Illustrations galore, giving not only full instructions on how to wind coils, but dimensions, size of wire, curves, how to plot them, by means of which any coil for any particular short wave set can be figured in advance, as to number of turns, size of wire, spacing, etc. There has never been such data published in such easy accessible form as this.

Sent to you upon receipt of  
**25c**  
in coin or unused U.S. Postage stamps.

**RADIO PUBLICATIONS,** 101C Hudson St., New York, N. Y.

Please Say That You Saw It in RADIO-CRAFT



## New 1936 DOERLE deluxe 5-tube short-wave A.C. RECEIVER

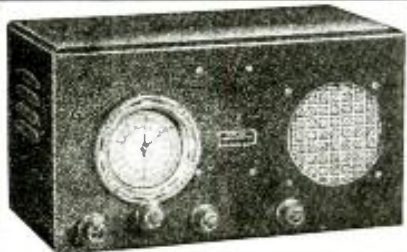

- featuring—
- ★ Range 15 to 550 Meters
  - ★ Handsread Dial
  - ★ Universal Antenna Input
  - ★ 8 Low-Loss Coils
  - ★ Large Dynamic Speaker
  - ★ Tone Control
  - ★ Ready to Operate
  - ★ Black Crackle Cabinet

COMPLETE PRICE  
**\$27<sup>52</sup>**  
No. RC 5000

### FREE 5-DAY TRIAL OFFER

Try this world-famous receiver in your own home for five days. Your money promptly refunded if you are not satisfied.

Hundreds of testimonials in our files attest to the superior performance of this wonderful set. Two tuned stages, regenerative detector, three A.F. stages with powerful pentode output and perfectly matched dynamic speaker—all contribute to place this set among the most reliable on the market. Uses 1 G50, 1 6F5, 1 6A7, 1 1H and 1 80. Sold complete with tubes. Say "Free 5-Day Trial" when ordering. \$1.75 extra. Set of Broadcast Coils.

Write for FREE 64-page Catalog.

**RADIO TRADING CO.**  
97 Hudson St. N. Y. C.

**THIS MAGAZINE NEEDS NO INTRODUCTION TO SHORT-WAVE FANS**

## SHORT WAVE CRAFT

This popular monthly magazine, **SHORT WAVE CRAFT**, contains everything you want to know about Short Waves. The wonders of world-wide short-wave reception are clearly described and illustrated. Latest practical information for radio fans, experimenters and "hams" will be found. Tells you how to build short-wave receivers and transmitters; construct sets of one and two tubes or as many as seven, eight or more. Tells best foreign stations to log and when to tune them—includes newest and best circuits of the time. **SHORT WAVE CRAFT** is edited by Haco Gerishback.

**NEW FEATURE RECENTLY ADDED**—To the short wave fan who has logged and obtained verification of the largest number of short-wave stations from all over the world during one month, will be awarded a magnificent 24" silver trophy.

### Special This Month Only!

For the month of December only, we offer readers of this magazine the opportunity to read Radio's greatest short-wave magazine at a special saving. The regular subscription price is \$2.50 per year. You can now get **SHORT WAVE CRAFT** for the next

**8 MONTHS FOR \$1.00**

4-Color Cover  
Over 200 illustrations  
9x12 inches in size

**25c** The Copy  
ON ALL NEWSSTANDS

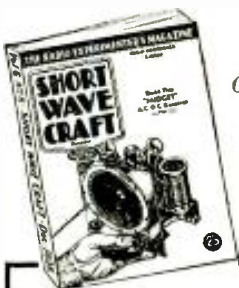

Send remittance by check, money order or U.S. Postage Stamps. Register letter if it contains cash or currency.

**SHORT WAVE CRAFT**  
99R Hudson St. New York, N. Y.

## A 1936 9-TUBE S.-W. COMMUNICATION RECEIVER

(Continued from page 417)

of the circuit, the phasing condenser will still give some control over selectivity. Of course, for C.W. reception, the crystal may be used in its most selective setting.

The beat oscillator is very helpful in locating weak phone signals. The tuning dial is set at the approximate position of the desired signal, the oscillator turned on, and if within range, a whistle will be heard when the station is passed. For C.W. signals the beat oscillator should be left on.

The beat oscillator is of the electron-coupled type, and changes in line voltage have no effect on its frequency. (The latter can be changed by means of a front-panel control.)

Two stages of A.F. amplification are used, the first being a high-gain 6F5 voltage amplifier, while the second is a 6F6 power pentode with an output of 3.5 W. The new *bias cell* is used in the grid circuit of the 6F5 and avoids the discrimination usually found in the customary resistor-and-condenser bias circuits, providing greater intelligibility on voice and musical signals. A special tone control circuit is used which allows either treble or bass to be changed without affecting the other.

The output circuit is arranged so that when phones are plugged into the jack, the speaker voice coil circuit is opened. A separate speaker can be used in this jack if desired, but for best results the impedance must be about 7,000 ohms. No D.C. flows through this circuit. These are the outstanding features of this set; still other features add to its efficiency and ease of operation.

## A 1-TUBE BATTERY-TYPE 5- AND 10-METER TRANSCEIVER

(Continued from page 417)

separated 1 $\frac{1}{2}$ -in. The 10-meter coil assembly consists of 2 windings of 8 turns each, using the same-size wire. Each winding occupies an axial length of 1 in. (from tip-to-tip each total coil assembly is 2 $\frac{1}{2}$  ins.) The R.T. choke coil consists of 70 T. No. 30 enameled wire wound on a 1 $\frac{1}{2}$ -in. insulated shaft. The 5-meter coils, being wound of stiff wire, require no form for support.

The super-regeneration present is due to grid blocking on the negative excursions of the R.F. energy. The tube draws practically no plate current at zero bias, and the negative alternations stop the plate current at a relatively low frequency. It is this interruption that prevents premature spillover and allows the oscillation to build up to enormous amplitudes. One tube as super-regenerator may be as sensitive as 5 tubes used in more accustomed fashion.

### LIST OF PARTS

- One Raco drilled and punched base and panel;
- One Universal single-button mike transformer;
- One special Raco 3-deck double-throw switch;
- One Hammarlund condenser, 25 mmf., 3-plate;
- Six Insuline tip-jacks, black;
- Two Insuline tip-jacks, red;
- One Insuline 6-prong socket;
- One 6-ohm rheostat;
- One "postage stamp"-type antenna condenser;
- One mica condenser, 250 mmf.
- One Raco R.F. choke;
- One 2,500-ohm 1 $\frac{1}{2}$ -W. resistor;
- One 15,000-ohm, 1 $\frac{1}{2}$ -W. resistor;
- One Raco dial plate and knob;
- One on-off toggle switch;
- Two Radio City pointer knobs;
- One Raco cabinet to match;
- One 4-wire cable;
- One Raco kit of coils, for 5 and 10 meters.

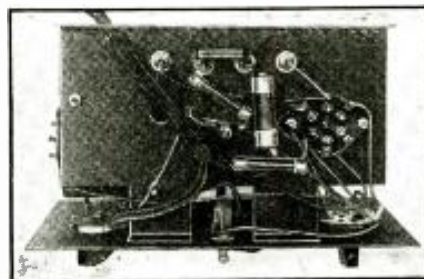

The underside of the transceiver chassis.

Please Say That You Saw It in RADIO-CRAFT

## New "DEPENDABLE"

### TUBE and SET TESTER

Model 305



Takes all glass and metal tubes—and roaming filaments. 5" fan-type, full-view "Good-Bad" meter scale. Simple to operate. No adapters required.

Ready to Operate: **\$21.95**

Kit: **\$17.85**

In addition to testing all tubes, this efficient instrument tests shorts and leakages above 500,000 ohms with neon light. Makes capacity and ohmmeter tests. Tests all types of condensers. Has separate line voltage meter. EFFICIENT—CONVENIENT—HANDSOME—LOW PRICED.

## New Model 121 POWER LEVEL INDICATOR



Complete: **\$25.85**—Kit: **\$21.00**

Important help for I.A. men. Measures power levels from minus 12 to plus 43 decibels. Highly-accurate 5" fan-type meter calibrated from down 12 to up 10 decibels. 500 microamp. movement. Knife-edge pointer. Unique 10,000 ohm constant impedance L-type attenuator. Also direct-reading, 4-range A.C. voltmeter for all frequencies.

Write Dept. RC-1 for New 1936 Bulletins

## RADIO CITY PRODUCTS CO. 88 Park Place, New York City

### LEARN TO SEND AND RECEIVE CODE



Whether you want to enter radio as a career, or merely add another valuable and fascinating ability to your avocational repertoire, TELEPLEX will help you!

**MASTER TELEPLEX**  
"The Choice of Those Who Know"

Learn to send and receive code signals, like operators on ships at sea and at commercial and amateur land stations. Intercept distress signals, news flashes, bulletins, and dozens of other kinds of interesting radio communications. TELEPLEX teaches you to receive code exactly the way the world's best operators do—by sound. Copper tape, running through a machine, operates an automatic key which sends messages to you, at any speed you desire. As you improve in speed, the machine sends faster, gradually preparing you for top-speed amateur and commercial signals. With the MASTER TELEPLEX you learn to send by sending, and the signals you send are repeated back to you, exactly as you sent them, thus enabling you to correct your own errors. We furnish a complete course, lend you the improved MASTER TELEPLEX and give you personal instruction with a MONEY BACK GUARANTEE. Send for our new TELEPLEX FOLDER A1 today. IT'S FREE!

TELEPLEX CO., 76 Cortlandt St., New York





**YOU CAN BUILD IT**  
**AND SAVE MORE THAN 50%**

Join the hundreds of DXers who have already seized this exceptional opportunity to own the most sensational communication receiver of the year—a at a tremendous saving!

If you want real proof of what it has done in actual short wave contacts, listen to the W. A. C. Boys sing its praises over the air... and read this letter which is typical of scores that are pouring in from the four corners:

"All contacts, with very few exceptions, have been 100%... all on phone on the 20 meter band... South America, Cuba, Haiti, West Indies, Mexico, Canada, East, West and South coasts of the U. S. have been made within the past three days. The permanent logging band spread works perfectly, and makes reception easier. The parallel crystal works perfectly in cutting 40M and background noise level is negligible. Have tried receiver on all bands and find it works perfectly, and with more than enough volume on all stations. Foreign broadcast stations come through effortlessly, with beautiful quality. I notice absolutely no image (repeat spots) which is certainly great, after the performance of my former receiver. Congratulations on the perfect engineering design, beautiful appearance and marvellous performance." Charles F. Grover (W4JZ), Engineer WFLD, Police Dept., Chicago, Ill.

**START FOR AS LITTLE AS \$7.30**  
**BUY THE PARTS AS YOU BUILD!**

The 32-page "HOW TO BUILD IT" Book (sent for 10c) tells the whole story of this amazing 10-Tube Superhet. You can build and align it in a few hours... or you can buy its standard parts from your local jobber as you build. If you haven't already got many of them.

**SEND 10c**  
 (stamps or coin)  
 for 32-page Book  
**"HOW TO BUILD IT"**

**SPONSORED BY:**

Hilley Piezo Electric Co., Crowe Name Plate and Mfg. Co., Hammarlund Mfg. Co., Chicago Trans-former Corp., Yazley Div. of P. R. Mallory Co., Jensen Radio Mfg. Co., Sprague Products Co., Continental Carbon Co., Ohmite Mfg. Co., Radio Shack Meter Works, Raytheon Instrument Corp., Al-ladin Industries, Inc., Steel Box & Mfg. Co., Filtronic Mfg. Co., Murdo Silver Corp.

Address:  
**R-S MERCHANDISING COMMITTEE**  
 1709 Roscoe St., Chicago, Ill., U. S. A.

**FREE—Just Out**  
**64 Pages**  
**Two Colors**

Contains thousands of illustrated radio items, P. A. equipment, receivers, short-wave sets, replacement parts, auto sets, etc., etc. Our low prices save you money. **DON'T DELAY! WRITE TO-DAY.** Send postcard or letter. Catalog by return mail. **IT'S FREE!**

**1936 RADIO BARGAIN CATALOG N°31**

**RADIO TRADING COMPANY**  
 HUDSON STREET  
 OFFICIAL DOERLE SHORT WAVE RECEIVERS

**RADIO TRADING COMPANY**  
 97 Hudson Street,  
 New York, N. Y.

**Radio Dealers & Servicemen!**

**S. O. S. CINEMAPHONE**  
 16 and 35 m. m. Talking Picture Equipment

Lowest Prices! Free Literature! may also be ideally used for Public Address

**S. O. S. CORP. 1600 B'way., N. Y. C.**

**Correspondence Courses in RADIO and ELECTRICAL ENGINEERING**

**ELECTRICAL ENGINEERING** covers complete electrical held.

**RADIO ENGINEERING** Ultra-modern course in radio, public address, photo-electric work. Trains you to be super-service man, real vacuum tube technician. Diploma given. Tuition only \$25. either course. Deferred payment plan.

**WRITE TODAY** for free copies of school catalogs, student magazines, etc. **SEND NOW**

**LINCOLN ENGINEERING SCHOOL**  
 889 C So. 37th St., Lincoln, Nebr.

**THE LATEST RADIO EQUIPMENT**

(Continued from page 416)  
**AIR CHARGER (879)**  
 (Kato Engineering Co.)

**POWER** for charging a 6 V. (for radio-set operation) or 32 V. (for farm lighting systems) storage battery is obtained by means of this windmill-driven, weatherproof generator assembly, which mounts in any conveniently high and clear space. Charging starts at about 10 m.p.h.; automatic cut-off counteracts high winds.

**ULTRA-SHORT-WAVE ANTENNAS (880)**

**SEVERAL** types and sizes of these antennas are made to fit all requirements; types suitable for 2½-, 5- and 10-meters are illustrated. At A is a rod with flattened end to fasten to stand-off insulators. The 2-section rod (B) which may be mounted on a single large stand-off insulator, is similar to C, which is capable of extension to about 9 ft. The doublet depicted at D is made of 2 rods with ends similar to that of A. Many arrangements of antennas and reflectors may be made with these units.

**LOW-PRICE DIRECT-READING ALL-WAVE SERVICE OSCILLATOR (881)**

(Clough-Brengle Co.)

**CONTINUOUS** coverage from 90 kc. to 20 mc. is secured for this new oscillator, which is calibrated in fundamentals. A special attenuator with interpolating control provides accurate calibration of output ratios. The need for trimmers has been eliminated. Output is 200 ohms, constant impedance, as R.F. (modulated and non-modulated) or A.F. (400 cycles). Utilizes two type 30 tubes.

**HANDSET FOR 5-METER TRANSCEIVERS (882)**

**THE RECEIVER** of this new handset, which is specially designed for use in ultra-short-wave transceivers, is available in either high (2,000 ohms) or low (70 ohms) D.C. resistance. Transmitter is of single-button, stretched-diaphragm type; resistance, 100 ohms, and normal current, 25 ma. Characteristics are excellent; weight about 14 ozs. Supplied with a 4-conductor cord.

**LINE-NOISE FILTER FOR ALL-WAVE SETS (883)**

**ELIMINATION** of high-frequency disturbances is claimed for this new filter. It is designed for use with all-wave receivers, transmitters, or



Below. Fuse mounting (888).



Left. New receiver (887).

Above. Set analyzer (889).

Below. Line antenna (890).



with any source of interference. Special dual-lateral chokes are used. Both inductive and capacitive filtering are used. The filter is made in 2, 5, 10, and 20 A. sizes. All are enclosed in a neat metal case, finished in black and chromium.

**"RATED LOAD" TUBE TESTER (884)**  
 (Triumph Mfg. Co.)

**THIS** instrument is designed to meet the requirements of the Tube Standards Committee of the R.M.A.—all tubes are classified under rated load by type of service. Other features include short tests, special line voltage regulation, isolation from the power line, solid walnut cabinet, assurance against obsolescence. May be used as a portable or counter instrument.

**"ACORN" AND METAL TUBE 5-METER RECEIVER (885)**

**AN "ACORN"-TYPE** pentode (the RCA Radiotron 954) is used in this new, novel 110 V., A.C., set as a broadly-resonant R.F. stage, giving added sensitivity. The detector stage incorporates a new circuit having exceptional efficiency. Excepting the "acorn" metal tubes are used in all positions. Includes tone, volume, and regeneration controls, and built-in power supply. Headphone and loudspeaker operation.

**ULTRA-SHORT-WAVE TUBE (886)**

**DESIGNED** especially for short-wave diathermy machines, this new tube has a rated output of 125 W. on 6 meters. It is similar to the 100 W. general-purpose tube but the plate and grid leads are brought out the top to facilitate short connections. A tungsten filament is employed, and the plate is completely insulated from the filament stem.

**NEWEST BROADCAST- AND SHORT-WAVE MIDGET SET (887)**

**THIS** set is contained in a case of moulded bakelite with an illuminated full-vision dial. The superheterodyne circuit with 5 tubes features A.V.C. and a range of 75 to 565 meters in 2 bands. A dust-proof dynamic speaker is used.

**"CODE" FUSE MOUNTING (888)**

**THE UNDERWRITERS** requirements (the "code") that a tool be necessary to remove the cover are met in this new fuse holder. It is of small size and takes the standard 3 AG radio fuse. All metal parts are cadmium plated.



Above. A new voltage regulator (891).

Below. Reflection meter (894).

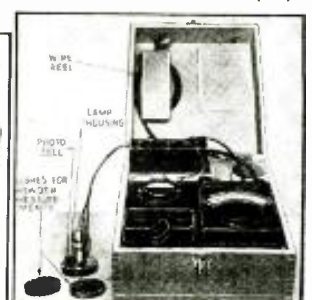

Please Say That You Saw It in RADIO-CRAFT



Over 130,000 People Find Each Issue of

**EVERYDAY SCIENCE AND MECHANICS of Intense Interest!**

EVERYDAY SCIENCE AND MECHANICS is the finest scientific-technical-mechanical constructional magazine in the field. Up-to-the-minute with news flashes of scientific events. Dozens of constructional articles and many popular experiments. Ideas from which you can make things to sell.

**A Host of Interesting Subjects Covered:**

Woodworking—Photography—Magic—Patents and Inventions—Book Reviews—Metalworking—Chemistry—Engineering—Microscopy—Electrical Experiments—Household Hints—Astronomy—Prize Contests—and other subjects.



10c

THE COPY

ON ALL NEWSSTANDS

OVER 150 ILLUSTRATIONS

*— a new magazine for short-wave fans!*

**SHORT WAVE LISTENER**

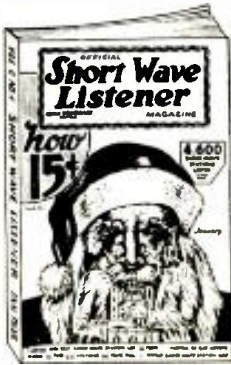

4,600 Short Wave stations listed

THE finest magazine of its kind ever published—totally different in get-up and contents from any other. Contains the largest listing of short wave stations in the world, up-to-the-minute. Including "Police," "Television," and short-wave stations, as well as a special list of the star short-wave stations with their frequencies and call letters. Also contains photos and descriptions of short-wave broadcasting stations in various parts of the world with photos of short wave studio artists

NOW 15c the Copy

—How to locate "weak" distance stations, and other hints for the "Short-Wave Listener"—Question and Answer Department for the "Listener"—Silver Cup Trophy for best photo of listening "Posts."

ON ALL NEWSSTANDS **SHORT WAVE LISTENER** 99 Hudson St. New York, N. Y.

**MORE \$\$\$\$ FOR YOU**

We can show you how to devote spare time to making money for yourself. Simple, easy work—only an hour or two a day, brings you extra dollar. AND, there's no limit to what you can earn. With this extra money you can buy things you want—or save your earnings. There's hundreds of things you can do with a few extra dollars. Everyone in your neighborhood is a prospect—your friends, relatives—all would be interested in what you have to offer. Write to us for your plan "EXTRA MONEY IN YOUR SPARETIME." We'll send you the details promptly. Address Circulation Manager

**RADIO-CRAFT** 99 Hudson Street New York, N. Y.

**LATEST IN SET ANALYZERS (889)**

(Radio City Products Co. Inc.)

TWO instruments are combined in one case, in this dual unit. They are: (1) a multimeter, having ranges for A.C. and D.C. voltages, and D.C. current readings (A triple-range ohmmeter is also included.); and, (2) an analyzer. Analyzer section is provided with spare switch points and cable wires to provide against obsolescence. Voltage and resistance measurements are free-reference-point.

**SHORT-WAVE AND BROADCAST LINE ANTENNA (890)**

(Continental Carbon Inc.)

THIS unit is used to replace the usual outside antenna, and works well down to 80 meters. Instrument consists of an R.F. choke and (connected to it on the line side) a condenser (provided with a pictail lead).

**NEWEST VOLTAGE REGULATOR (891)**

(Raytheon Mfg. Co.)

CONSTANT output voltage of 115 V. plus or minus 1 per cent (with input from 95 to 130 V.) is delivered by this device. Made in power ratings of 60, 120, 250, and 500 W. has no moving parts.

**A.C.-OPERATED PREAMPLIFIER (892)**

DESIGNED to bring the level of a crystal microphone up to that of the ordinary carbon microphone, this unit is small and entirely self-contained. Wax-sealed transformers utilize cast cases. Input impedance, 5 megs.; output, 200 ohms. Gain is 35 db. Case, 9 1/2 x 6 x 3 1/2 ins. deep.

**NEW TRANSFORMER FOR AMATEUR AND EXPERIMENTER (893)**

THE transformer illustrated is representative, in appearance, of a new line that has been designed. There are over 130 different numbers in the series, covering virtually every need of the amateur and experimenter.

**REFLECTION METER (894)**

THIS unique apparatus is used for measuring the relative whiteness of any substance. Entirely self contained, and carries meters necessary for proper operation. In order to be free from line voltage variations, a small storage battery is fitted inside the case. Also included is a rectifier for charging the battery from A.C. lines. The "head" consists of a small lamp in a housing, the bottom of which contains the photoelectric cell.

Preamp. (892)

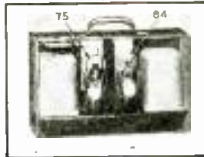

Trans. (893)



**AN "ACORN"-TYPE ULTRA-SHORT-WAVE SUPERHETERODYNE**

(Continued from page 412)

batteries, or an A.C. power supply unit delivering 6.3 V. for the filament and up to 300 V. for the plate.

To simplify the arrangement of the parts and to eliminate trimming and aligning troubles, separate controls are provided for the R.F. and detector stages. Tiny plug-in coils, only 1/2-in. in diameter, are provided for the 2 1/2- and 5-meter bands.

**"The Most Complete Radio Parts Catalog Ever Published!"**

**FREE!** **RADOLEK 1935**

For 14 years I have supplied the Radio Service Man with his Radio Parts—every year the Radolek catalog has been the most complete published—Now I am offering you the largest and finest Radio Parts Catalog of my entire career—Previous editions of the RADOLEK PROFIT GUIDE were the best of their kind—but this Big New Book far exceeds anything you've ever seen—it's colossal—gigantic—it's the "top"—Contains over 1600 pages—10,000 individual Radio Repair Parts—hundreds of Special Items—Radio Receivers—Amplifiers—Everything in Radio—always in stock, ready for prompt delivery to you—at the right prices—You need this superb "Buying Guide"—I want you to have it—just send coupon—I'll mail it to you—Free.

Send For The **RADOLEK PROFIT GUIDE**

*W.C. Braun*

**RADOLEK**

**FREE! MAIL THIS COUPON**

THE RADOLEK CO. 648 W. RANDOLPH ST. CHICAGO, ILLINOIS

Radolek restricts distribution of this catalog to active and qualified Radio Men. Please enclose your business card or letterhead, with this and you'll receive your copy of the RADOLEK PROFIT GUIDE, FREE

NAME .....

ADDRESS .....

SERVICE MAN?  DEALER?

Experimenter?

**The New AUTONATOR**

delivers 110 VOLTS A.C. IN CARS AND TRUCKS

The new AUTONATOR generates 110 Volt A.C. Current in motor cars, aeroplanes and from all types of engines and motors. Direct from fan belt. Costs nothing to operate. No service—no brushes, collector rings, commutator or wire wound armature. Ideal for operating PORTABLE Sound equipment, A.C. Radio Sets, Neon Signs, Electric Lights, searchlights. Send for complete details.

**AUTONATOR LABORATORIES, Inc.** 8440 South Chicago Avenue, Dept. RC, Chicago, Illinois

**New BIRNBACH 5-Meter ANTENNAS \$1.00 to \$5.25**

LARGE variety, including 10 new types of quarter and half-wave antennas for portable transceivers, beam arrays and permanent use. 2 to 6 extensible sections with threaded end, or flat end for direct front-panel mounting, or including highest grade ceramic standoff insulator—\$1.00 to \$5.25 list. Ask us about special antennas for all ultra high-frequency transmission and reception.

Write Dept. RC-1 for Data

**BIRNBACH RADIO CO., Inc.** 145 Hudson Street, New York City



**We SPECIALIZE in the Design and Manufacture of Public Address Amplifiers**  
**SEND FOR FREE CATALOG!**  
**Number K-30**  
 Describes in detail 86 different models and complete P.A. Systems ranging up to 200 audio watts output, 6 volt; AC; DC.  
**Buy Direct from Manufacturer AND SAVE BIG MONEY**  
**Coast to Coast Radio Corp.**  
 559-R Sixth Ave. New York, N. Y.

**COLUMBIA 18 WATTS CLASS "A" HIGH FIDELITY AMPLIFIER**



With two-channel mixer for Ribbon &/or Crystal Microphones, Pick up, etc., complete with 6 tubes, \$40.00 Ribbon or crystal mike, Dynamic Speaker, (provision for additional speakers optional) neat and sturdy portable case, cables, etc., ready to operate... List Special Offer... **\$119**

COLUMBIA SOUND CO., Inc., 135R Liberty St., New York City

**ALL FOR 10c** **DICTIONARY OF RADIO DEFINITIONS**  
**5 FAMOUS CIRCUITS**  
**EAGLE RADIO**  
 AND VALUABLE INFORMATION

Cannot Be Obtained Under One Cover Elsewhere! Complete Symbols used in Radio Circuits. Frequently used Formulas. Proper Grid-bias for 28 Standard Tubes. Complete IEMA Color Code. International Morse Code. Diagrams and Technical Data for building 4 FAMOUS EAGLE ALL-WAVE SETS and AC-DC MIDGET HOUR LIT. Dictionary of Radio Definitions. All Radio Terms defined and explained. Characteristic chart of New Metal Tubes, etc.  
**DON'T HESITATE—WRITE NOW!**  
 Enclose 10c in stamps or 1c, which only covers the cost of handling and mailing this valuable technical information.  
**EAGLE RADIO Dept. RC-1, 84 Cortlandt St., New York City**

**RADIOS..SAVE UP TO 50%**

**DEAL DIRECT: Factory Prices** Many models to select from AC-DC, all-wave, Farm, Car and new metal Tube Models. Your name and address on postcard brings you NEW 1936 page 1936 Bargain Catalog in colors FREE. Get details of 30-DAY TRIAL plan and Agent-Lear proposition.  
**Goldentons Radio Co., Dept. 222**  
 8780 Grand River, Detroit, Mich.

**AMPLIFIERS AND SOUND SYSTEMS**

High power low cost Amplifiers and Systems for every purpose, from 3 1/2 Watts to 100 Watts, incorporating every advanced engineering feature and modern design. Sound systems for halls, restaurants, theaters, schools, churches, stadiums, auto and all types of outdoor and indoor installations. Also, a complete line of Microphones, Dynamic Speakers, Portable Sound Systems, Exponential Horns, Electric Phono, Pick Up, Phono, Motors, Recording Equipment, Tubes, etc.  
 Write for complete catalogue.  
**INTER-WORLD TRADE CORP.**  
 315 Fifth Ave. New York City

**QUALITY RADIO SUPPLIES**

1936 Catalog featuring hundreds of new items x-mitter, receiver and transceiver parts—television and short wave equipment, apparatus and items of interest to all radio enthusiasts. Send 10c in stamps or coins to cover cost of handling and mailing.  
**INSULINE CORP. OF AMERICA**  
 25 Park Place New York, N. Y.

**Actual Troubles in Radios**  
 By BERTRAM M. FREED  
 Consists of 200 pages (48 diagrams) of proven solutions to service breakdowns which have stood the test of time. Tells how to locate and make repairs on over five hundred different model receivers. One free supplement. For sale by leading mail-order houses and radio parts jobbers, or direct from us. Price \$1.00.  
**SERVICEMEN'S PUB. CO.**  
 172 Washington St. New York City

**RADIO COURSES**  
**RADIO OPERATING:** Prepare for Gov't License Exam. ● **RADIO SERVICING:** Including Short Wave ● **AMATEUR CODE**  
 ● New Course in **ELECTRONICS:** Day and Evening Classes.  
 Booklet Upon Request  
**NEW YORK YMCA SCHOOLS** 4 W. 64th St. N. Y. City

**INFORMATION BUREAU**

(Continued from page 413)

**HEADPHONE CONNECTION**

(356) Mr. P. J. De Jon, Hartford, Conn. (Q.) I have a 6 tube Jupiter set. How can I connect headphones to this outfit?  
 (A.) We have no record of this make set, so exact directions are impossible. However, the general method is as follows: connect one phone tip to the ground; connect the other to one side of a .1-mf. condenser, the other side of which runs directly to the plate of the output tube. If a push-pull output stage is used, connect a .1-mf. condenser in each side of the phones, and run the other side of each condenser to one of the output tube plates.

**P. A. FORUM**

(Continued from page 413)

shall be flat within 2 db. between 50 and 7,500 cycles. Hum and other extraneous voices to be at least 60 db. below peak-power output between 150 and 5,000 cycles and at least 10 db. below outside that range.

**TYPES OF BIAS**

(28) Mr. Samuel Burns, Ontario, Canada. (Q.) What is the essential circuit differences of self-bias, fixed-bias and semi-fixed bias arrangements?  
 (A.) The three types are illustrated in Fig. Q.28. In self-bias circuits the bias voltage is developed by the plate current of the tube itself through its cathode to ground resistor. Fixed bias is a voltage produced by some separate rectifier (or battery) entirely independent of the plate current of the tube to which it is applied. Naturally it remains fixed during all plate current fluctuations. Semi-fixed bias circuits obtain grid voltage from some point on the bleeder system which is at the required potential below ground. Naturally as the total current flowing through this bleeder is semi-fixed, it furnishes a grid bias intermediate in characteristics to self- and fixed-bias arrangements.

**POWER CONVERSION**

(29) Mr. Jack Adler, Boston, Massachusetts. (Q.) How can I convert the output watts of an amplifier into db?  
 (A.) Assuming a zero reference level of 6 milliwatts, the formula is

$$db = 10 \log \frac{ow}{.006}$$

where db output level in db. ow output watts of amplifier.

**"'QUALITY-CONTROL' AN AID TO OLD SETS"**

(A Correction)

In November 1935 Radio-Craft page 276, an unfortunate error occurred in the above-titled article by Mr. C. K. Krause. In this article, Fig. 2 shows the vacuum tube without plate-current supply connection; an error which is corrected in the illustration below.

Note also that the high-frequency inductance indicated in Fig. 3 of the article, is a 200-millihenry inductance. This coil is made by winding 2,170 T. of No. 28 enameled wire, at random, to the dimensions given in the figure. Service Men interested in improving the response of old sets should refer to this interesting and instructive article.

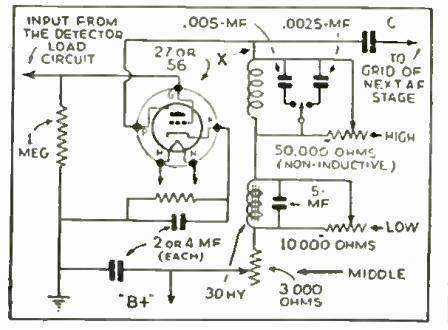

**NEW Dependable Test Equipment**

**Dependable OHMMETER Models 405 and 405A**

DEPENDABLE OHM-METER Model 405 is an accurate double range instrument reading from 0-1,000 and 0-100,000 ohms. Measurements of less than 1/4 ohm can be made. The D'Arsonval moving coil meter has a guaranteed accuracy of 2%. Provisions are made for easily adding milliammeter and voltmeter ranges provided in Model 405A. DEPENDABLE OHM-METER Model 405A is identical to Model 405 but has four additional voltmeter scales of 0-2.5; 0-25; 0-125 and 0-750. There are also the current ranges of 0-2.5 and 0-125 milliamperes. The panel, meter and case are the same for both models, the 405 and 405A. They are both furnished complete with self-contained batteries.



Size: 7 1/2" x 4" x 3"; Weight: 1 1/2 lbs.  
 Model 405—Complete, ready to operate... **\$8.45 NET**  
 Model 405A—Complete, ready to operate... **\$9.95 NET**

**Dependable MULTITESTER Model 403-A**



Service men and dealers highly praised the Model 403 Multitester—and it deserved praise. But the new improved Model 403-A "DEPENDABLE" MULTITESTER insures even greater satisfaction at less cost. Embodying every feature of the former model, No. 403-A is more compact, having been designed as a companion instrument to the new Model 501 ANALYZER UNIT.

COMPLETE, READY TO OPERATE  
**\$13.95** Net  
 In Kit Form **\$10.65**

2,000 ohms per volt. Accuracy within 2 per cent in D'ARSONVAL type moving coil meter. 3-range 0-2,000,000 ohmmeter; 4-range 0-5-50-250-750 voltmeter; 0-500 microammeter.

**We Issue No Catalog** All orders are F.O.B. New York. Terms: A deposit of 20% is required with every order. Balance may be paid on delivery. DEDUCT 2% IF FULL AMOUNT IS SENT.  
**GRENPARK COMPANY**  
 101 Hudson St. Dept. RC New York, N. Y.

Please Say That You Saw It in RADIO-CRAFT



**CLASSIFIED ADVERTISEMENTS**

Advertisements in this section are inserted at the cost of twelve cents per word for each insertion—name, initials and address each count as one word. Cash should accompany all classified advertisements unless placed by a recognized advertising agency. No less than ten words are accepted. Advertising for the February, 1936, issue should be received not later than December 31st.

**A.C. AUTO GENERATORS**

**TWENTY PRACTICAL AND LOW-COST CHANGES** converting old generators into new generators and motors 100-500 watt capacity, dc or ac current, with 6 to 100 volts, for radio operation, power, light, or welding. Also instructions for rewinding armatures. 370 definitions of electrical terms, etc. All in new, revised book with simplified instructions and illustrations. Endorsed by thousands. Only \$1.00 postpaid. Autopower, 414-C S. Hoyne Ave., Chicago.

**MISCELLANEOUS**

**WAGNER MOTOR AND GENERATOR SET** especially built for broadcasting purpose. 2,200 volt, 1 1/2 amp. Price \$145.00. I. C. Patsch & Son, Houston, Penna.

**PHOTO CELLS**

**PHOTO CELLS**—REMARKABLE RESULTS OBTAINED with Pese Cells. Only \$1.50. Pese supersensitive relays replace relays at double the price. Only \$3.00. Helps the invisible watchman. Three-cent stamp brings details. Pese Scientific Products, 1918-19th Avenue, Brooklyn, New York.

**RADIO**

**RADIO ENGINEERING, BROADCASTING, AVIATION** and police radio, servicing, Marine and Morse Telegraphy taught thoroughly. All expenses low. Catalog free. Dodge's Institute, Pine Street, Valparaiso, Indiana.

**TRADE YOUR USED TEST EQUIPMENT ON NEW** Line models Supreme, Tru-Set, Weston, RCA Oscillograph, etc. Liberal allowance, lowest prices. Lyon-Watt Radio Wichita Kansas.

**IMMEDIATE DELIVERY—SHIPPED PREPAID** \$17. per Skyriver \$79.50; Super-Sevens \$17.50; Brothing 12's \$95.00; Silver 51's \$109.50; PK 16's \$95.70; RBE-69's \$151.50; ACR-136's \$69.50. Trade in your receiver. Henry Radio Shop, Butler, Missouri.

**HOW TO MAKE THE RADIO-CRAFT METAL-TUBE ALL-WAVE OSCILLATOR**

(Continued from page 414)

as broadcast stations) is all that is needed to properly set the dial scale. One small additional compensation is needed. Since the coil and condenser were calibrated for use with a type 30 tube which has an input capacity of 3 mmf. and we are using a 6L7 having an input capacity of 1.9 mmf., we must add 1.1 mmf. to the input capacity to make the circuit constants match. This is accomplished by taking two pieces of cotton braid hookup wire about 3 ins. long and twisting them tightly together, leaving one end of each wire open and connecting the other end to the cap and cathode of the tube (see Cx which represents this additional capacity).

The output of the oscillator is fed through a shielded line to a 1,000 ohm potentiometer, shunted by a 100 ohm resistor and a switch. When this switch, Sw.1, is open, the greatest output is obtained, and when closed, the low range is in effect.

The A.F. oscillator consists of a low-ratio A.F. transformer connected backwards; that is, with the usual secondary in the plate circuit and the primary in the grid circuit. This is done to obtain the greatest output and the widest frequency range. The frequency of this oscillator (modulator) is controlled by a unit consisting of a group of condensers and a fan switch. Since the exact frequencies produced by each capacity combination on this switch depends on the characteristics of the A.F. transformer and other circuit values, it is not calibrated. This can be done with the use of a piano and a frequency scale corresponding to the standard piano frequency range. The tones of oscillator and piano are matched and the scale is used to determine the oscillation frequency (as heard in headphones plugged into the "A.F. Output," and "Output Common" binding posts.)

The power supply for the signal generator is a *voltage-doubler* arrangement, containing a switch for permitting operation on a D.C. line, with an additional 90 V. "R" battery to build up the voltage to 200 for *reliable operation* of the oscillator. A double-section filter is used to reduce the A.C. or ripple component to the lowest possible value—to prevent 60-cycle modulation of the R.F. oscillation.

**THE CONSTRUCTION**

The construction of the signal generator is not difficult, if the specified parts are used. The dial should be converted first, by removing the scale disc and pasting the paper scale which comes with the coil assembly over the original one. To remove the scale, loosen the screw holding the knob in place and push the shaft back. The scale will then snap out. The paper scale should be secured to the dial with rubber cement, so that it does not wrinkle. Next, the transparent celluloid window should be removed and a new one made, which extends the full length of the aperture in the dial. This is necessary since the 7 scales cover the entire space, and in the original window, the index line did not extend the full length of the window. A knife blade will serve to scratch a line in the new celluloid window vertically from top to bottom. The scratch may be filled with india ink if desired.

Mount the parts in the approximate positions shown in the photos, and when this has been done, wire the unit carefully. No special instructions are required for this job, except the usual ones to keep wires as short and direct as possible. Be extra careful with the soldered joints, as this may determine whether the oscillator is really satisfactory or not.

**ADJUSTMENTS**

The adjustments necessary are few in number. When the unit has been completed, connect it to a 110 V. line and connect a shielded wire to the R.F. output terminal and the "Output Common" terminal, which, by the way is isolated from the unit by a .1-mf. condenser so that "fire works" are not seen when the line plug is inserted in the socket the wrong way. Connect the shielded wire to the aerial binding post of a receiver and tune the set carefully to a number of broadcast stations one after the other, the frequencies of which are known:

**Lafayette 5 METER Superhet Receiver**



**6 Tubes**

- ★ Using New 951 Acorn Pentode Tubes in R.F. and Audialyne Detector stages.
- ★ Reduced Thermal Noises, Low Noise Level, Increased Sensitivity.

Lafayette engineers offer another season in presenting this 5 meter receiver in which the noise level is practically negligible due to the use of the acorn pentode type 951 tubes. A phono path is provided for reception of all but the weakest signals on loud speaker while new type high-resistance, noiseless dials are used. Here is a unit that will appeal to every amateur, particularly those accustomed to the use of super-regenerative receivers in which "rush" is an outstanding and annoying noise characteristic.

CY 21934 Lafayette 5 meter Acorn Superhet receiver with 6 tubes in cabinet less tubes, power supply and speaker **\$26<sup>50</sup>**

**BRANCHES AT**

- CHICAGO—401 W. Jackson Blvd.
- ATLANTA—149 W. Peachtree St.
- NEWARK, N.J.—211 Central Ave.
- IRVING, N.Y.—42 E. Fordham Rd.

**CLIP & MAIL TODAY**

Wholesale Radio Service Co., Inc., 100 Sixth Ave., Dept. CX-16, N.Y. City

I enclose \$\_\_\_\_\_ for order described in attached letter. Check here if interested in our Special New Ham Catalog. IT'S FREE

Name \_\_\_\_\_

Address \_\_\_\_\_

City \_\_\_\_\_ State \_\_\_\_\_



**PYROHM JR. RESISTORS**

Genuine wire-wound vitreous-enamel resistors. Most compact. 5, 10, 15 and 20 watt ratings. All resistance values. For midget sets and crowded assemblies. For stay-put servicing.

Crack-proof refractory tubing. Adequate heat dissipation. Wire ends brazed to lugs. Pigtailed soldered to terminal bands.

Quality resistance wire. Space wound under tension. Heavy vitreous enamel coating. Permanent seal against moisture and damage.

**DATA** Send for new catalog covering complete condenser and resistor line. Also largest listing of exact duplicate replacements. Sample copy of Research Worker included.



77 Washington St. : : Brooklyn, N. Y.

**TYPEWRITER BARGAIN**

10-DAY FREE TRIAL OFFER



FREE HOME TYPING COURSE

ONLY 10¢ A DAY

BRAND NEW MODEL No. 5

**REMINGTON PORTABLE**

● A brand new Remington for only 10c a day. An easy, practical Home Typing Course FREE. With it anyone quickly becomes expert on this machine...the most rugged, dependable portable made. Not used or rebuilt. Standard 4-row keyboard. Standard width carriage. Margin release on keyboard. Back spacer. Automatic ribbon reverse. Every essential feature of big office typewriters. Carrying Case FREE. Try it for 10 days without risking a cent. If you don't agree it is the finest portable at any price, return it at our expense. Don't delay. Without obligation, write now. Remington Rand Inc., Dept. 189-1, 205 East 42nd Street, New York, N.Y.

**BUILD IT YOURSELF**

You can build this Trailer with ordinary tools easily from our step-by-step constructional sheets and large sized blueprints. Finest designed Trailer in existence, sleeps 4. Toilet. Shower. Electric Light, etc. Save 75% of the cost by building it yourself. Send 25c for plans sheet, illustrations and details. **THE PLAN SHOP, 910 Palmolive Bldg., Chicago, Ill.**

If you are interested in servicing electric refrigerators, turn to page 433 of this issue and read the advertisement on the Second Volume of the OFFICIAL REFRIGERATION SERVICE MANUAL.

Please Say That You Saw It in RADIO-CRAFT



### The RACO

**One Tube (19 Tube) Transceiver**



An inexpensive 1-tube 5 and 10 meter transceiver. This extremely efficient transceiver is recommended for the short-wave enthusiast who is interested in exploring the fascinating 5 and 10 meter bands. This circuit utilizes the type 19 two volt twin tube, and is exceedingly sensitive since the super regenerative principle is employed, when the receiving position is switched on. Batteries required are two 1½ volt dry cells and 90 to 135 B supply. Complete kit with (2) 5-meter coils and dial, less batteries **\$4.75**

- Cabinet, 75c. • 10 meter coil, 50c
- Wiring, assembly, \$1.50. • Tube, 65c.

Write in for new Free List of 5- and 10-Meter Equipment

**RACO** RADIO CONSTRUCTORS LABORATORIES  
136 Liberty St., N. Y. C., N. Y. Depl. RC4

### PHILA.'S

## SHORT WAVE HEADQUARTERS

We carry a complete line of parts for all the new short wave circuits appearing in this magazine and other periodicals.

**— IN STOCK —**

New Patterson PR-16	All Star Jr. & Sr. Browning 35 Hammarlund Thordarson
National HRO	Hammarlund
Sargent Marine	Thordarson
All Wave Model	Triplet & Dayrad
New Silver	Service Instruments
9 to 200 meter super.	

**M & H Sporting Goods Co.**  
512 MARKET ST. PHILADELPHIA



### UNIVERSAL

**A. C. HUMLESS POWER SUPPLY**

This absolutely silent power unit supplies perfect pure direct current at 200 v. and 20 mls. direct from any 110 v. 50-60 socket—For use with condenser microphones, photoelectric cell amplifiers, etc. Will also supply both A and B D.C. current to amplifiers of condenser or other type microphones using No. 230 tubes.

**Dealers Net Cash \$23.52**

**UNIVERSAL MICROPHONE CO.**  
424 Warren Lane Inglewood, Calif., U.S.A.

### ★ SERVICEMEN ★

Complete line Replacement Parts, Short Wave and All-Wave Receivers, Amplifiers, Test Equipment and Accessories. All at Rock Bottom Prices.

**CONSOLIDATED RADIO PRODUCTS CO.**  
Box 23 Northwestern Sta. Detroit, Mich. Dept 22K

FREE  
•  
NEW  
1936  
RADIO  
BARGAIN  
CATALOGUE

### SERVICEMEN!

If it's TEST EQUIPMENT or RADIO PARTS you need—WRITE US FIRST. We carry only Nationally known lines. Dealer's prices quoted. You SAVE MONEY when you buy from us. Write for our BARGAIN BULLETIN—chock full of SPECIALS. We ship to all parts of the world.

**M. SCHWARTZ & SON**  
710-712 Broadway Schenectady, N.Y.

## RADIO ENGINEERING,

broadcasting, aviation and police radio, servicing, marine radio telegraphy and telephony, Morse telegraphy and railway accounting taught thoroughly. Engineering course of nine months' duration equivalent to three years of college radio work. All expenses low. Catalog free. School established 1874.

**Dodge's Institute, Hudson St., Valparaiso, Ind.**

and on the basis of this, set the dial of the oscillator to the correct point and lock the set screw on the dial tightly in place.

If it is desired to use only the R.F. oscillator without modulation, the modulation switch, Sw.2, should be snapped to the off position.

If the A.F. oscillator only is desired, this switch should be in the on position but the output should be taken from the "A.F. Output" terminal and the "Output Common" terminal.

If wider A.F. modulation is needed than provided by the modulations of the A.F. oscillator, additional condensers can be shunted across C11. Or if for any reason a separate modulator is to be coupled to the R.F. signal generator, the "External Modulation" terminal should be used and Sw.2 should be placed in the off position.

A little study of the circuit and this rather sketchy description of the construction and operation of the unit will reveal how really flexible the unit is.

#### LIST OF PARTS

- One RCA oscillator coil kit, L1 to L20, type 9559, (including dial scale, two snap switches Sw.1 and Sw.2, and jack J1);
  - One RCA cond., 9.5 to 290 mmf., type 3980, O2;
  - Two .1-mf. Cornell-Dubilier 400 V. condensers, C1, C5;
  - One Cornell-Dubilier 100 mmf. condenser, C3;
  - One Cornell-Dubilier .001-mf. condenser, C6;
  - Four Aerovox 8 mf. 250 V. electrolytic condensers, C7, C8, C9, C10;
  - \*One tapped condenser bank 50 mmf. to .01-mf. type 1200TA, C11;
  - One Clarostat 1,000 ohm non-inductive potentiometer with switch, Sw.3, R1;
  - One Aerovox 100 ohm, 5-W. carbon resistor, R2;
  - One Aerovox 50,000 ohm, 5-W. resistor, R3;
  - One Aerovox .2-meg. 5-W. carbon resistor, R4;
  - \*One 50,000 ohm potentiometer, R5;
  - One Blau power cord, with 254 ohm resistor, R6;
  - One Hammarlund 10 mhy. R.F. choke, type CH10-S, R.F.C.1;
  - \*Two midget filter chokes, Ch.1, Ch.2;
  - \*One midget A.F. transformer, T1;
  - Three ICA Insulite octal sockets;
  - One Blau D.P.D.T. snap switch, Sw. 4;
  - One Blau aluminum chassis, 8¾ x 4¼ x 2¼ ins. high;
  - \*One type B dial;
  - \*One cabinet;
  - One National Union type 6L7 metal tube, V1;
  - One National Union type 6F5 metal tube, V2;
  - \*One MG25Z5 metal-glass tube, V3;
  - Five Blau binding posts;
  - One I-A. fuse;
- As needed, screws, hookup wire, etc.  
(\*Name of manufacturer sent upon request.)

### BOOK REVIEW

**TELEVISION**, by K. A. Hathaway. Published by the American Technical Society, Chicago, Ill., 1933. Size, 6 x 8½ ins., 170 pages, cloth bound. Price \$2.00.

It contains a brief resume of the history of television, as well as a review of the elementary principles of light and of optics. A complete chapter is devoted to an explanation of the A.T. & T. Co. system of facsimile transmission. Photo-electric cells and glow lamps are dealt with individually as are the various forms of mechanical scanning devices. The chapter on electrical scanning, namely, cathode ray tubes, has been treated entirely too briefly.

Contents include: Principles of Television; History of Television; Principles of Light; Optics; Photoelectricity; Reproducing Devices; Facsimile Transmission; Scanning Devices; Receiving Circuits; Motors; Electrical Scanning.

**MODERN RADIO SERVICING** by A. A. Ghirardi. Published by Radio Technical Publishing Co., New York. Size 6 x 8¼ ins., 1300 pages. Price \$4.00.

This large volume is one of the most complete ever published on the subject of radio service. Every conceivable angle is covered, including sales equipment building, auto and marine radio, etc.

The first 400 pages are devoted to elements of electricity, especially as they apply to measuring instruments, and the construction of all types of testing equipment, including commercial apparatus and chapters on home-built equipment.

Service Men, both beginners and experienced, will find this treatise of great assistance in their work.

### MOTOR DRIVEN

## Craftsman Tools

COMPLETE—READY TO RUN

### ELECTRIC HANDY-LATHE

PRICE **\$757**



Ship. weight 10 lbs.

**WITH BUILT-IN MOTOR**

Length of Bed, 15 inches; height to spindle, 2 inches, is supplied with face plate as well as spur center for handling all types of work. This lathe is furnished with a built-in Induction Motor, mounted on the head-stock, so that the drive wheel acts directly on the three-speed pulley. **NO BELT REQUIRED.** In shifting to the various speeds it is only necessary to lift the motor with the left hand and slide it forward or back as desired. A finger-tip switch is located conveniently on top of the motor. Finished in gray and green enamel and comes complete with motor, cord and plug cap, and special wrench. Operates on alternating current only, 110 volts, 60 cycles.

### ELECTRIC GRINDER

PRICE **\$349**



Ship. weight 4 lbs.

Comes supplied with 2 genuine Aloxite grinding wheels, one coarse grinder, and one fine grinder. It is driven with a dependable induction type high speed inner fan cooled motor with the grinding wheels mounted at opposite ends of the motor shaft. This motor does not interfere with radio reception, and has a heavy ground steel shaft and large bronze bearings, having thick felt oil-retaining washers behind them, constantly lubricating the shaft and bearings and provided with oil holes for re-oiling. Complete with cord and plug cap. Operates on alternating current only, 110 volts, 60 cycles.

### ELECTRIC SCROLL AND JIG SAW

PRICE **\$469**



Ship. weight 10 lbs.

This is an entirely new type of saw, powered by a fan-cooled, induction motor geared directly to a saw blade for maximum power.

Blade stroke ¾". Made of channeled steel, has 12" throat that handles work up to 24" long, 6½" round work table, adjustable hold down shoe with guide roller to support and steady saw blade. Cord, plug and 1 blade included. Built-in motor operates on alternating current only, 110 volts, 60 cycles.

**Our Old Customers Know That Our Merchandise Is Sold on a Strict Money-Back Guarantee**

All Shipments will be forwarded by Express Collect if not sufficient postage included with your order.

**WELLWORTH TRADING CO.**  
506 Palmolive Bldg., Dept. R. C. 136, Chicago, Ill.

Please Say That You Saw It in RADIO-CRAFT

# 12 BOOKS TO HELP YOU LEARN MORE ABOUT RADIO

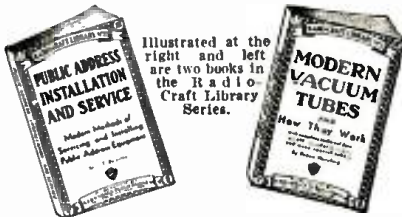

Illustrated at the right and left are two books in the Radio-Craft Library Series.

**THE RADIO-CRAFT LIBRARY SERIES**—a most complete and authentic set of volumes—treats individually, important divisions of radio. Each book has been designed to give you the opportunity to learn one or more branches of radio. The authors of the books are well-known to everyone. Each is an expert radio man; an authority on the subject—each is thoroughly familiar with the field which he represents.

### All Books Uniform

The volumes in the RADIO-CRAFT LIBRARY SERIES are all uniform, 6 x 9 inches. Each book contains on an average of 50 to 120 illustrations. The books are printed on an excellent grade of paper which makes the type easy reading.

### Here Are the Series:

- Book No. 1  
**RADIO SET ANALYZERS**  
And How to Use Them By L. VAN DER MEL
- Book No. 2  
**MODERN VACUUM TUBES**  
And How They Work By ROBERT HERTZBERG
- Book No. 4  
**MODERN RADIO HOOK-UPS**  
The Best Radio Circuits By R. D. WASHBURNE
- Book No. 5  
**HOW TO BECOME A RADIO SERVICE MAN**  
By LOUIS MARTIN
- Book No. 6  
**BRINGING ELECTRIC SETS UP TO DATE**  
By CLIFFORD E. DENTON
- Book No. 7  
**RADIO KINKS AND WRINKLES**  
For Service Men and Experimenters By C. W. PALMER
- Book No. 8  
**RADIO QUESTIONS AND ANSWERS**  
By R. D. WASHBURNE
- Book No. 9  
**AUTOMOBILE RADIO AND SERVICING**  
By LOUIS MARTIN
- Book No. 10  
**HOME RECORDING AND ALL ABOUT IT**  
By GEORGE J. SALIBA
- Book No. 11  
**POINT-TO-POINT RESISTANCE MEASUREMENTS**  
By CLIFFORD E. DENTON
- Book No. 12  
**PUBLIC ADDRESS INSTALLATION AND SERVICE**  
By J. T. BERNSELY

## BIG DISCOUNT OFFERED

When Five (5) Books or More Are Ordered, Deduct 20% from Your Remittance

**GERNSBACK PUBLICATIONS, INC.**  
99 Hudson Street, New York, N. Y.

### MAIL THIS COUPON TODAY!

GERNSBACK PUBLICATIONS, INC.  
99 Hudson Street, New York, N. Y.

I have circled below the numbers of books in the RADIO-CRAFT LIBRARY SERIES which you are to send me, and have deducted 20% for ordering five (5) books or more. I have included my remittance in full, at the price of 50c each, when less than five books are ordered.

The amount of my remittance is..... Circle numbers wanted:  
(stamps, checks or money orders accepted).

1 2 3 4 5 6 7 8 9 10 11 12

Name .....

Address .....

City ..... State.....  
All books are sent postage prepaid RC-136

## A NEW POWER-LEVEL METER

(Continued from page 415)

is comparatively large. When a smaller voltage is applied to the instrument, the resistance of the rectifier is high; but, since the multiplier is not changed for a given range, the value of the multiplier is too high to produce a linear scale. The first requirement of a multiplier for copper-oxide voltmeters, therefore, is that it be so high, compared to the highest resistance of the rectifier, that variations in rectifier resistance do not appreciably affect the meter reading.

### THE DECIBEL SCALE

The decibel (abbreviated db.) is a convenient measure of the increase or decrease in the level of a sound. Such changes in sound level cannot be expressed in watts or volts without interpreting the significance of the change. Thus, double the power output of a device represents a considerable increase, as far as power is concerned. On a decibel scale, double the power output corresponds to an increase of 3 db., which is a little more than a perceptible increase in sound intensity. The decibel scale can be calibrated directly on the meter scale, provided that the device is connected across a line of fixed impedance. The most common impedance line is 500 ohms, and most db. scales are calibrated for this value of line impedance; when used on a line having any other impedance value, the scale calibration must be changed.

It should be noted that the db. level represents the output compared to some arbitrary power level. In most cases, this level is 0.006-W. Thus, for a 500-ohm line, the reference voltage is 1.73 V. (See "Valuable 'Decibel' Data," July, 1935 Radio-Craft, page 27.—Editor)

### A PRACTICAL POWER-LEVEL METER

Figure A is a photograph of a power-level meter, the characteristics of which satisfy the requirements set forth in this article; the schematic circuit of the device is shown in Fig. 1. Considering, for a moment, the section enclosed by points ab, it is seen that the multiplier has a resistance of 9,000 ohms and that a 0.5-ma. meter is used. The resistance of the rectifier with the D.C. meter connected across it is 1,000 ohms at about 80 per cent of full-scale reading. It should be pointed out here that the value of this multiplier varies considerably with the type of rectifier used and also between rectifiers of the same type. Of course, the necessary compensation is made during the calibration of each instrument. Thus, the fixed multiplier constitutes 90 per cent of the total multiplier resistance; variations in the rectifier resistance, therefore, permit a nearly uniform voltage scale to be used. It must be emphasized that even the slight variations (in per cent) in the rectifier resistance do not affect the accuracy of the scale calibration, since the scale calibration is determined with the multiplier, rectifier, and D.C. meter normally connected.

Every resistor used in this attenuator must be hand calibrated to within 2 per cent of the values stated, and must be wired with the shortest possible leads to the switch. This is accomplished in the unit illustrated by a unique scheme whereby the resistors are mounted on, and wired to the switch during the assembly of it (See Fig. B). Thus, the shortest possible leads are insured.

Each step in the attenuator adds 3 db. to the meter reading. To read the db. level, it is only necessary to adjust the attenuator setting so that the meter reads some convenient value; then add the meter reading to the attenuator reading for the total. The meter scale is calibrated directly from -12 to +10 db. and the attenuator adds 33 db.; the total range of the instrument therefore is 55 db., or from -12 to +43.

Since the addition of 3 db. increases the voltage range by 1.41, it is possible to calibrate several voltage scales directly on the meter scale. Each voltage range, therefore, corresponds to a different setting of the attenuator. The power-level meter shown has 4 such voltage scales, each one corresponding to a setting of the attenuator, as follows:

Voltage Range	Attenuator Setting	Ohms-per-volt Sensitivity
0-5	0	2,000
0-20	12	500
0-80	24	167
0-160	30	62.5

## CHEKATUBE \$16.95



Model C111  
**NEW TESTS ALL METAL AND GLASS**

Try it—no adapters. Try it 10 DAYS FREE and see a swell instrument that does more than most \$35 testers. **HIGHEST QUALITY**—has everything. Large accurate meter—neon short test that shows plate shorts automatically, and any shorted element—even the metal tube shield. **PORTABLE TYPE** 10 x 11 x 6 weighs 10 lbs. **ORDER TODAY** or send for FREE literature.

Established 1922 J-M-P Manufacturing Co., Inc. Milwaukee, Wis.  
3040 N. 34th St.

## NOW! H. G. Cisin's TWO METAL TUBE ALL ELECTRIC AIR SCOUT



Only Set of its kind in the world

Pat. Pending U. S. Serial No. 592,586. Operates on A.C. or D.C. Self-Contained Power Supply.

**POWERFUL**—Many Air Scout owners report reception from England, Germany, Spain, Rome and other foreign stations. Wonderful short wave reception. Broadcast reception on indoor aerial. Police calls, code, aeroplanes and Trans-Atlantic phone conversations. **NEW METAL TUBES**—GREATER EFFICIENCY. Four plug-in coils cover 10 to 200 meters. Extra coils for Broadcast Reception, also special Long Wave unit. Operates several handsets simultaneously. Speaker on strong stations. **Complete, Assembled Kit, with instructions and picture diagram, and all four short wave coils, without tubes, \$29.95 ready to wire.**

Set of 2 Matched Metal Tubes.....\$2.50  
Special Long Wave Unit......95  
Earphone (Single)......50  
Coil......32.50  
Broadcast Coils (Two).....\$1.45  
Total.....\$9.25  
**Special Combination Offer—Assembled Kit, not wired, 2 metal tubes, 7 coils including Long Wave Unit, \$34.00 Earphone**  
Above, Custom Built, Wired and Laboratory Tested, ready to use \$1.00 extra.  
H. G. CISIN, Chief Engineer, Allied Engineering Institute  
Dept. CR-3 98 Park Place, New York, N. Y.

## 7-TUBE SUPER KIT

Kit Includes: ANTENNA COIL; R.F. COIL; OSCILLATOR COIL; 1st I.F. COIL; 2nd I.F. COIL; 3-GANG TUNING CONDENSER. Price **\$1.95**  
Schematic circuit diagram for A. C. and Auto Receiver furnished.



### T.R.F. KIT

ANTENNA COIL; 2 R.F. COILS; 3-GANG DEJUR TUNING CONDENSER. Price **\$1.25**  
Write for our special circular radio parts and tubes.  
Send enough money for parcel post or we ship by express collect.  
**ARROW SALES CORPORATION**  
549 West Randolph St. Chicago, Illinois

## THE NEW ALL-ALUMINUM PARABOLIC DEFLECTOR BAFFLE

with Weather-proof Speaker Housing

HOPE ALL ALUMINUM PARABOLIC DEFLECTOR BAFFLES assure a most effective sound distribution and completely minimize feedback difficulties. Constructed of heavy gauge spun aluminum reinforced, and beautifully finished with special aluminum lacquer. Any cone speaker can be easily and quickly mounted on the housing making the assembly ready for immediate operation. Model illustrated is suitable for all 10, 11, and 12 inch cone speakers.  
Write Dept. RC for illustrated literature on HOPE Horns and Trumpets. A complete line of attractively low priced.  
HOPE MANUFACTURING CO. 401 Broadway New York, N. Y.



Please Say That You Saw It in RADIO-CRAFT





## • RECORDS through a RADIO

Any radio, whether or not it has a connection for a phonograph pick-up, can be made to reproduce records. All you need is a turntable, and the RCA Phonograph Oscillator. To the service man and dealer, it offers a profit in itself and through the future sale of records; to the set owner, it immensely increases the enjoyability of his instrument. Simple to install. Priced at \$7.57 net, less tube. Can also be used with a microphone as a public address system. For further information, write for descriptive circular Form FM15, to Dept. RC.

**RCA PARTS DIVISION**  
 RCA Mfg. Co., Inc., Camden, N. J.  
 A subsidiary of the  
**RADIO CORPORATION OF AMERICA**

**"Pleased"**  
 with the Hi-Fidelity of the Model 1750... the Reproducer with the New

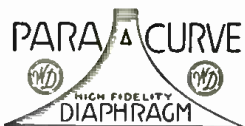

It's what OTHERS say that COUNTS!

Read the following letter:

Pass Christian, Miss., Oct. 14, 1935

"Gentlemen:  
 Recently I received one of your new No. 1750 Para-Curve Reproducers and I am more than pleased with its Hi-Fidelity performance. Please rush 1 Model 1750 to match a new Philco Model 650X."  
 Eldridge A. Helwick

**\$17.50**  
 List

Write for complete catalog, dealer's discount and name of nearest distributor. Wright-DeCoster distributors are always anxious to cooperate with you.



Model 1750  
 12" Reproducer

**WRIGHT - DECOSTER, Inc.**  
 2251 University Ave., St. Paul Minn.

Note that the low ranges have high sensitivity, suitable for accurate measurement of low voltages; the high ranges have high enough sensitivities for the accurate measurement of line voltages or the accurate measurement of high voltage across the low-resistance voice coils of speakers.

The accuracy of the instrument is not impaired by the use of a crowded scale. The meter is a 5-in. flange-type instrument which spreads the scale so that low levels may be read.

### THE NUMEROUS USES OF THIS UNIT

The power-level meter may be used in circuits for the measurement of voltage or decibel levels up to frequencies of 10,000 cycles with little error. It can be used wherever an output meter is required and whenever a calibrated attenuator is necessary. It is an indispensable instrument for P.A. work, and, when properly used, can render invaluable service to the radio Service Man. It can be connected directly across the voice coil or primary of the output transformer (with the voice coil open-circuited) when lining up receivers. It can be used for measuring line and filament voltages. It can be used in determining frequency-response and gain measurements. In a few weeks of active duty, this instrument will more than repay its small initial cost.

The separate parts of this instrument may be procured in kit form, less panel and wood case, for mounting on your own panel. When wired as instructed, the indicated calibration is valid. In the kit assembly, the resistors and rectifier are already mounted and wired to the switch, as previously described. Only 4 wires are needed to complete the wiring.

### ORSMA MEMBERS' FORUM

(Continued from page 422)

with the exception of 3 loose wires, evidently caused by those cockroaches, nothing was wrong with it.

I surely don't want a job like that again.  
 ANDREW M. WIEHL,  
 Portland, Oregon.

We can offer no comment, except to strongly echo Mr. Wiehl's last line by saying that we don't want a job like that ever. Unfortunately Mr. Wiehl's experience is not an isolated instance; servicing restaurant sets often entails a messy job.

### AN OLD QUESTION RAISED

RADIO-CRAFT, ORSMA Department:

I notice not only in *Radio-Craft*, but in other periodicals and texts, and at lectures, that Service Men either go to the customer's home to diagnose a receiver trouble, or else they take the set to their shops for checking, only to find (for instance) that not only is the filter condenser "out" as they had told their customer, but when the condenser is properly replaced, a cathode bias resistor or condenser is also "bad" (resulting in distortion); and not only that, but the antenna coil is shorted, or some other combination of faults is present.

Some time ago a friend of mine brought in a wildcat set that he had taken to another shop for analysis. He was told that it had a faulty filter condenser, which could be replaced for \$2.00. After I got the set I found a low emission 42 tube used as a rectifier, a lost-capacity filter condenser of the 8-8 mf. type, and a bias condenser and resistor that were useless. How could the other Service Man fix up a set like this for \$2.00? Or how could he even guess at its various faults unless he took all the parts out for test?

On another set, a Cub 4-tube midset, the volume control was open, the antenna coil was shorted, the screen-grid resistor was low in value, the tuning condenser plates were shorting and the set was badly out of balance. How could any Service Man determine all these things in a customer's home, and estimate accurately on the job in any reasonably short length of time?

AL HOLTZ,  
 Chicago, Ill.

We would like to have the opinions of ORSMA members on this question. It raises the old, much-discussed question of the advisability of working in the customer's home, or in the shop.

### Index to Advertisers

Aerovox Corporation	A	443
Allied Radio Corp.		419
American Technical Society		436
Anstey Radio Cor.		426
Arco Tube Company		130
Arrow Sales Corp.		415
Automator Laboratories, Inc.		441
<b>B</b>		
Birnback Radio Co.		411
Brush Development Co.		432
Burnstein-Appelbee Co.		436
<b>C</b>		
Capitol Radio Engineering Institute		427
Central Radio Laboratories		126
R. G. Cisin		413
Classified Section		443
Clough-Bingler Co.		443
Coast-to-Coast Radio Corp.		431
Columbia Sound Co., Inc.		412
Consolidated Radio Products Co.		411
Cornell-Dubilier Corp.		432
Coyne Electrical School		385
<b>D</b>		
Dodge's Institute		444
<b>E</b>		
Eagle Radio Company		412
Electrad, Inc.		421
<b>F</b>		
Freed Radio Company		136
<b>G</b>		
General Cement Mfg. Co.		134
General Electric Company		Back cover
General Transformer Corp.		138
Globe Apparatus Co.		127
Goldentone Radio Co.		412
Greenpark Company		435, 412
<b>H</b>		
Hammarlund Mfg. Co.		432
Hope Mfg. Co.		445
Hygrade-Sylvania Corp.		429
<b>I</b>		
Insuline Corp. of America		442
Inter-World Trade Corp.		442
International Correspondence Schools		437
International Resistance Co.		436
<b>J</b>		
J-M-P Mfg. Company		415
<b>K</b>		
Ken-Rad Corporation		426
<b>L</b>		
L & L Electric Company		428
Lincoln Engineering School		410
Arthur H. Lynch, Inc.		430
<b>M</b>		
M & H Sporting Goods Company		441
Midwest Radio Corp.		Inside back cover, 435
<b>N</b>		
National Radio Institute		388A
National Union Radio Corp.		424
New York YMCA Schools		442
<b>O</b>		
Oxford Radio Company		438
<b>P</b>		
The Plan Shop		443
Popular Book Corp.		439
Precision Apparatus Corp.		424
<b>R</b>		
R-S Merchandising Committee		440
Radio & Technical Pub. Co.		423
Radio Circular Company		421
Radio City Products Company		439
Radio Construction Labs.		411, 444
Radio Publications		437, 438
Radio Trading Company		439, 440
Radio Training Association		389
Radiolec Company		411
Raytheon Production Corp.		433
RCA Institutes, Inc.		434
RCA Mfg. Co., Inc.		446
Readrite Meter Works		425
Remington Rand, Inc.		413
Rosterclan Order		434
<b>S</b>		
S. O. S. Corporation		440
M. Schwartz & Son		444
Sears, Roebuck & Company		437
Service Men's Pub. Co.		442
Solar Mfg. Co.		435
F. L. Spravberry		430
Standard Transformer Corp.		121
Supreme Instruments Corp.		Inside front cover
<b>T</b>		
Tefft Radio Co.		438
Teleplex Company		439
Thor Radio Company		427
Triplet Elec. Instrument Co.		387
Try-Mo Radio Co.		427
<b>U</b>		
Universal Microphone Co.		444
<b>W</b>		
Wellworth Trading Company		437, 441
Wholesale Radio Service Co., Inc.		434, 443
Wright-DeCoster, Inc.		446

(While every precaution is taken to insure accuracy, we cannot guarantee against the possibility of an occasional change or omission in the preparation of this index.)

Please Say That You Saw It in RADIO-CRAFT

only  
**MIDWEST**  
*Gives You an*  
**18-TUBE Radio**  
*(for Metal or Glass Tubes)*

SIX TUNING RANGES  
 4½ to 2400 METERS  
 FULL SCOPE  
 HIGH FIDELITY  
 PUSH BUTTON TUNING  
 ROBOT EAR  
*and Scores of Other  
 Features for*

**\$59.50**  
 (LESS TUBES) *with New  
 GIANT  
 THEATRE-  
 SONIC  
 SPEAKER*

**SAVE UP TO 50%** *Direct FROM MIDWEST  
 LABORATORIES*

No middlemen's profits to pay. You buy at wholesale price, direct from Laboratories... saving 30% to 50%. You can order your 1936 Midwest radio from the new 40-page catalog with as much certainty of satisfaction as if you were to come yourself to our great laboratories.

You save 30% to 50%... you get 30 days FREE trial... as little as \$5.00 down puts a Midwest radio in your home. You are triply protected with a One-Year Guarantee, Foreign Reception Guarantee and Money-Back Guarantee.



**30 Days  
 FREE Trial!**

**GUARANTEED FOREIGN RECEPTION**

This super radio will out-perform \$200 and \$300 sets on a side by side test. It is so powerful, so amazingly selective, so delicately sensitive that it brings in distant foreign stations with full loud speaker volume, on channels adjacent to powerful locals. The 18 tubes permit of advanced circuits, make it possible to use the tremendous reserve power, and to exert the sustained maximum output of the powerful new tubes.

**80 SENSATIONAL ADVANCEMENTS**

Scores of marvelous Midwest features, many of them exclusive, explain Midwest glorious tone realism, super performance and thrilling world-wide 6-band reception. They prove why nationally known orchestra leaders like Fred Waring, George Olsen, Jack Denny, etc., use a Midwest in preference to more costly makes. Pages 12 to 21 in FREE catalog illustrate the new Midwest features. Study them before you make up your mind.

**PUSH BUTTON TUNING**

Simply pushing Silencer Button silences set between stations. Beautiful tuning lights automatically indicate when station is properly tuned. Release button... and station comes in perfectly. Pressing Station Finder Button (Midwest's exclusive ROBOT EAR) automatically determines proper dial position for bringing in extremely weak stations.



**GINGER ROGERS AMAZED AT MIDWEST PERFORMANCE**

*Holl wood, California.*  
 "Your Midwest is a wonderful instrument. The tone quality is delightful and it surpasses any set I have ever owned. I have heard station from all over the world. I got a thrill the first time I tuned in on the booming of 'Big Ben'."  
 GINGER ROGERS



**TERMS AS LOW AS \$5.00 DOWN**

ONCE again Midwest demonstrates its leadership by offering the world's most powerful Super De Luxe 18-METAL Tube 6-Tuning Range radio. It is a master achievement... today's most highly perfected, precisely built, laboratory adjusted set. It is a radio-musical instrument that will thrill you with its marvelous super performance... glorious new acousti-tone... crystal-clear "concert" realism... and magnificent foreign reception. Before you buy any radio, write for FREE 40-page 1936 catalog. Learn about the successful Midwest Laboratory-To-You policy that saves you 30% to 50%... that gives you 30 days FREE trial.



Send for FREE 40-page four-color catalog. It pictures the complete line of beautiful 1936 Midwest Acousti-Tone V-Spread consoles... and chassis... in four colors.

**SIX TUNING RANGES**

This exclusive engineering triumph puts Midwest radio years ahead of ordinary sets and makes them the "World's Greatest Radio Values." Now, it is easy to make the nations of the world parade before you. You can switch instantly from American programs to Canadian, police, amateur, commercial, "secret," experimental, airplane and ship broadcasts... to the finest and most fascinating programs from Europe, Africa, Asia, Australia, South America... 12,000 miles away.

**ACOUSTI-TONE V-SPREAD DESIGN**  
 (U. S. Patent No. 96750)

The V-Front Dispersing Vanes established a new radio style overnight. They spread the beautiful face-work of the "highs" throughout the room in a scientific manner... directing the High Fidelity waves uniformly to the ear. Now, get complete range of audible frequencies from 50 to 16,000 cycles... achieving glorious new acousti-tone... assuring like-like crystal-clear "concert" realism.

**MAIL COUPON TODAY! FOR  
 FREE 30-DAY TRIAL OFFER and 40-  
 PAGE FOUR-COLOR FREE CATALOG**

**MIDWEST RADIO CORP.,  
 Dept. 12P, Cincinnati, Ohio**

Without obligation on my part, send me your new FREE catalog, complete details of your liberal 30-day FREE trial offer, and FREE Miniature Rotating 18-tube Dial. This is NOT an order.

User-Agents  
 Make Easy  
 Extra Money

Check Here  
 for  
 details

Name: \_\_\_\_\_  
 Address: \_\_\_\_\_  
 Town: \_\_\_\_\_ State: \_\_\_\_\_  
 Check here, if interested in a Midwest All-Wave Battery Radio



**MIDWEST RADIO CORP.**  
 DEPT. 12P CINCINNATI, OHIO U.S.A.  
 Established 1920 Cable Address MIRACO All Codes



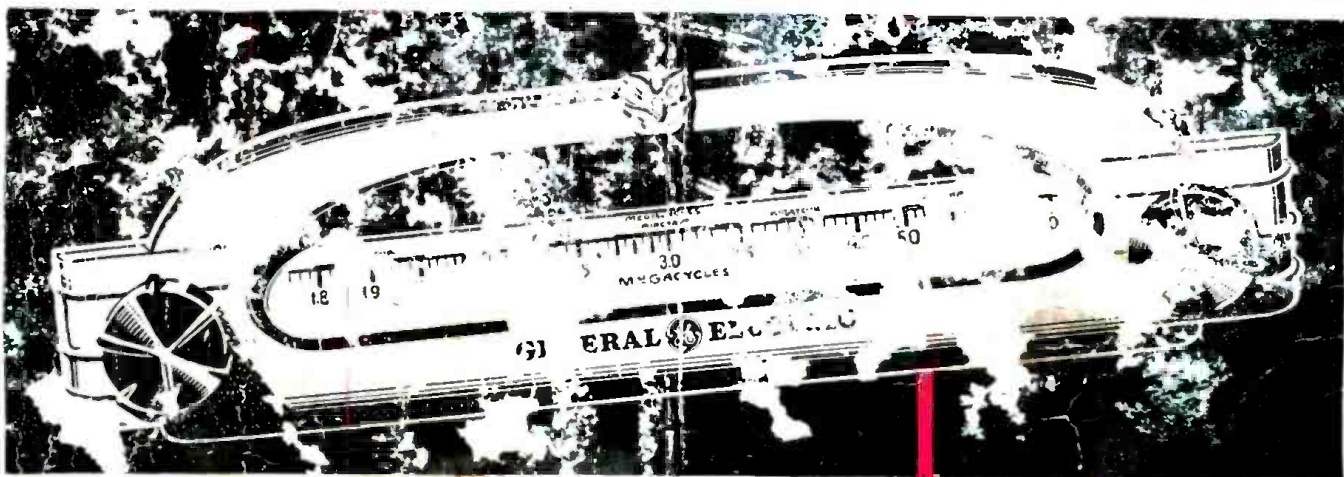

# HERE'S THE "TOPS" IN TUNING



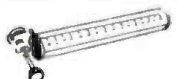

## ... the sliding-rule tuning scale

 **EASY TO READ.** The scale is accurately calibrated in kilocycles on standard broadcasts, and megacycles on short-wave. It's "as easy to read as a ruler."  
 **LISTS ALL STATIONS IN A LINE.**

There's no confusion in locating the desired station on the dial. Each scale lists all stations in a straight line.  
 **ONE BAND VISIBLE.** No congestion of broadcasting bands on this scale. Only one band is visible at a time. Just a turn of the control knob and another band moves into view. The receiver is automatically aligned to the new reception band.

 **AUTOMATIC VERNIER TUNING.** An ingenious mechanical arrangement regulates the dial pointer automatically to fast or slow motion with single knob. It eliminates the awkward "in or out" positions of the conventional single knob as well as the clumsy "double-deckers."

 **READ IT SEATED OR STANDING.** The graduations are visible from either a sitting or standing position.

 **THIS IS BUT ONE OF FIVE OUTSTANDING FEATURES.** Together, they give not only a new brilliance of performance, but a lasting brilliance that the years cannot dim.

**GENERAL  ELECTRIC**  
**RADIO**

**WITH THE TUBE THAT'S "SEALED IN STEEL"**

MERCHANDISE DEPARTMENT, GENERAL ELECTRIC COMPANY, BRIDGEPORT, CONN.

**SEE IT! HEAR IT!  
 COMPARE!**

**MODEL A-82.** This model has established new records in world-wide and amateur short-wave reception. Eight Metal Tubes. Four Reception Bands. Sentry Box. Permaliners. Stabilized Speaker. Sliding-rule Tuning Scale. Noise Control. Lo-note Compensation. CW Oscillator may be added.

**\$94.50**  
 (Eastern List Price)

